

“No.1 Quilt Pattern Collection” Manual

This manual contains real-scale figures and shows how to make them after pieces are prepared for sewing using the cutting machine. When making the patterns 1 to 45, cut out pieces with seam allowance. Refer to machine’s Operation Manual for detailed instruction. When printing out real-scale figures, print at 100% or set your printer so that it will not enlarge or reduce the scale.

Note: Use these same methods when machine sewing. Refer to your machine instruction manual for information about different stitch lengths and reinforcement stitches. Quilting presser feet made for your machine will also help sewing measured 1/4” seam allowances at all turns. Refer to the following for an explanation of “mark ends” and “set-in seam” described in this document.

Mark ends (Seam starting or ending point)

“Mark ends” is the sewing method used when sewing fabrics together until the end mark.

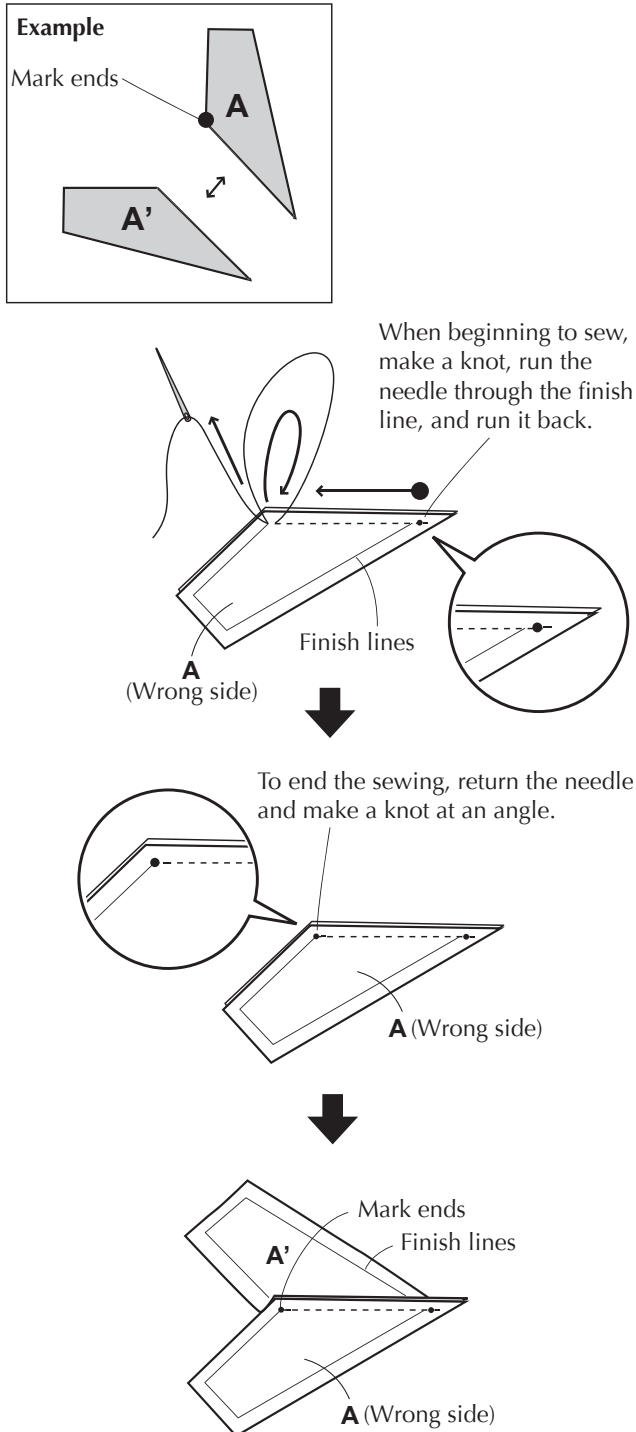

Set-in seam

“Set-in seam” is a method that uses multiple continuing stitches, rather than cutting off the thread each time.

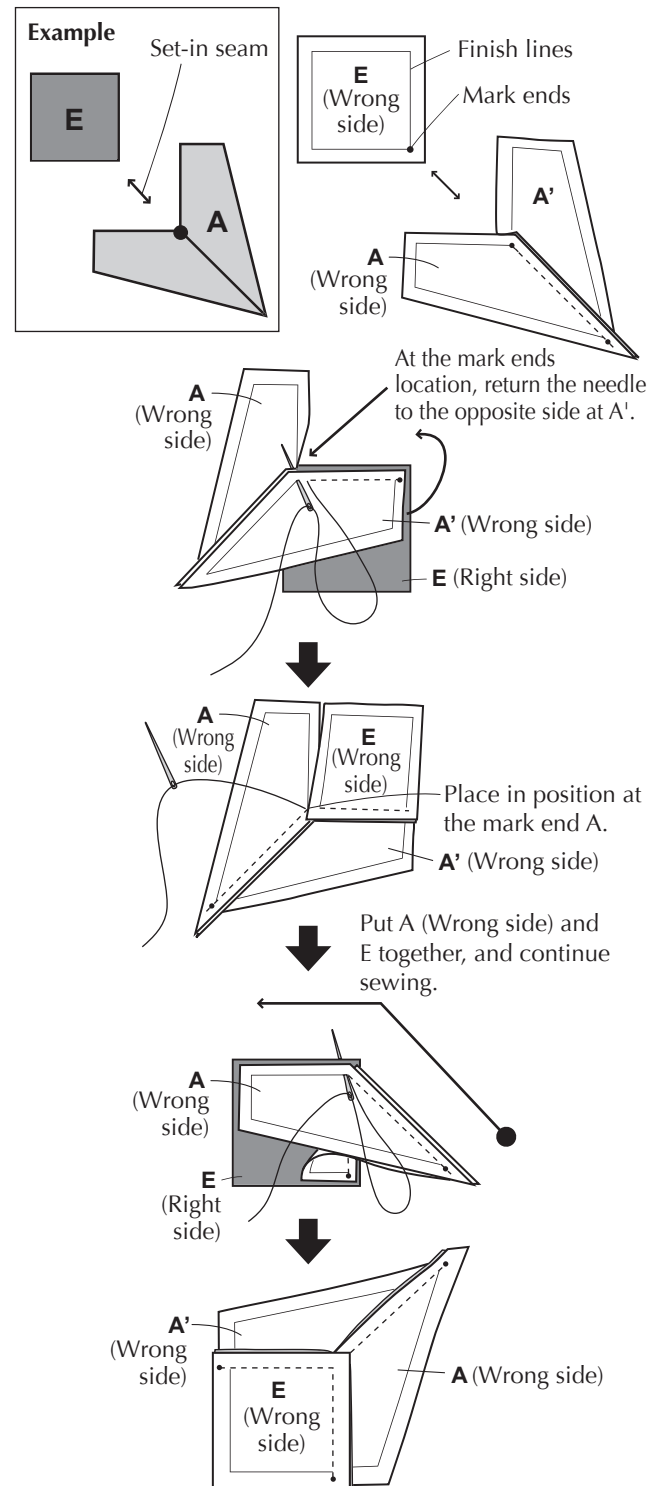

1

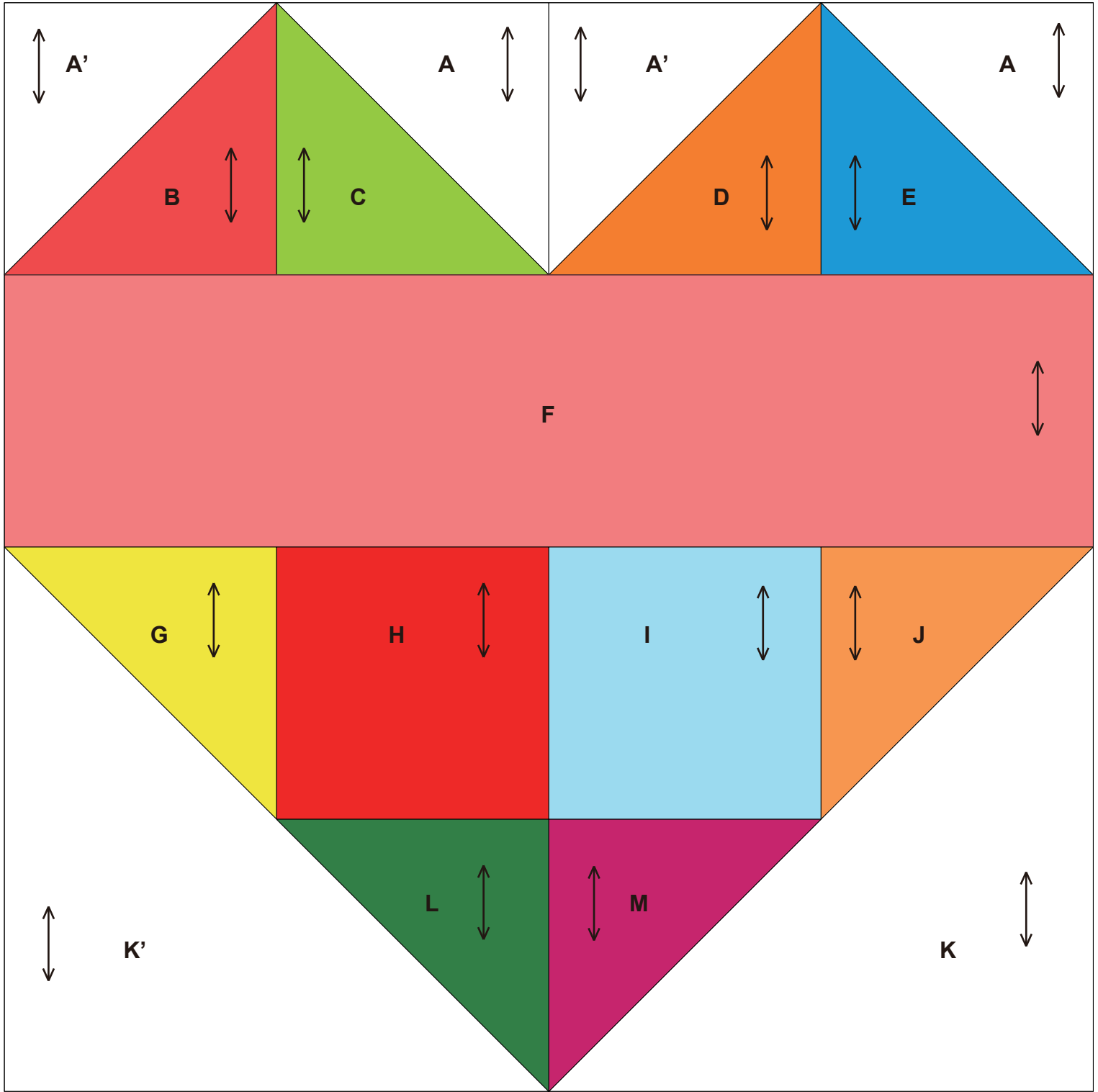

0 1 2 3 4 inches(")

0 50 100 mm

1 Signature heart

Illustration of finished item

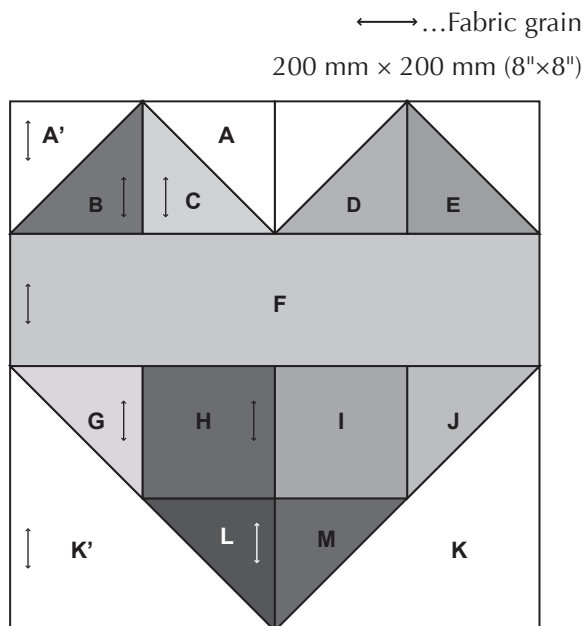

How to make

• Make the top block

1 Sew together **A'** and **B**, **A** and **C**, **A'** and **D**, and **A** and **E**.



2 Sew together, as shown in the figure.

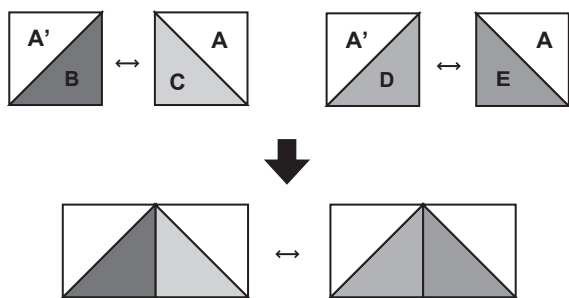

3 Sew on **F**.

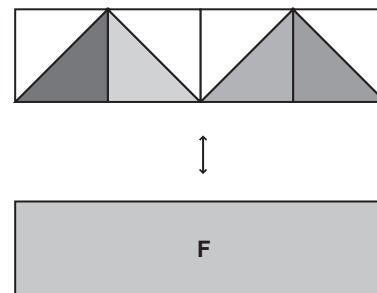

• Make the bottom block

1 Stitch **G** and **L** onto **H**, and then sew on **K'**.

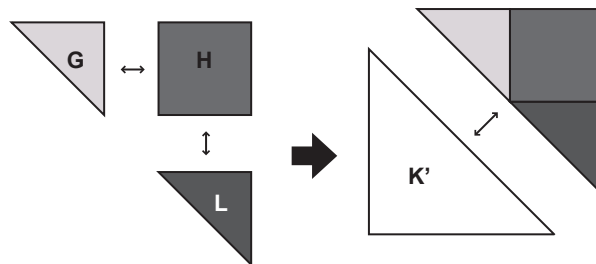

2 Stitch **J** and **M** onto **I**, and then sew on **K**.

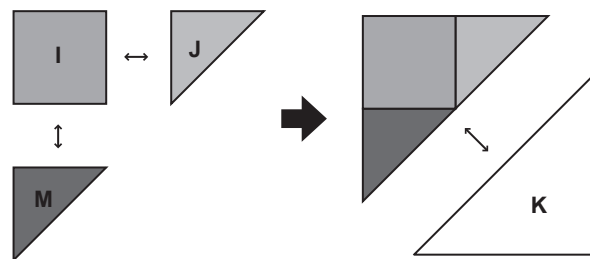

3 Sew together the left and right blocks.

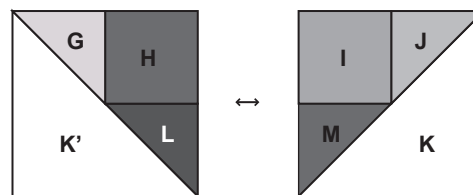

- Sew together the upper and lower blocks

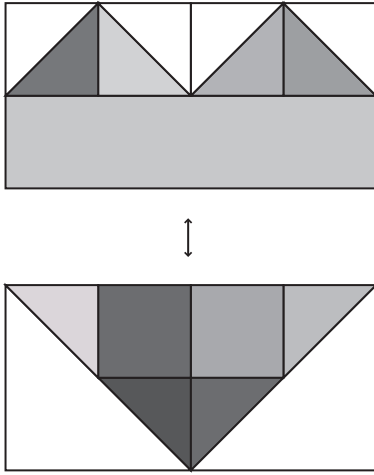

The task is completed.

2

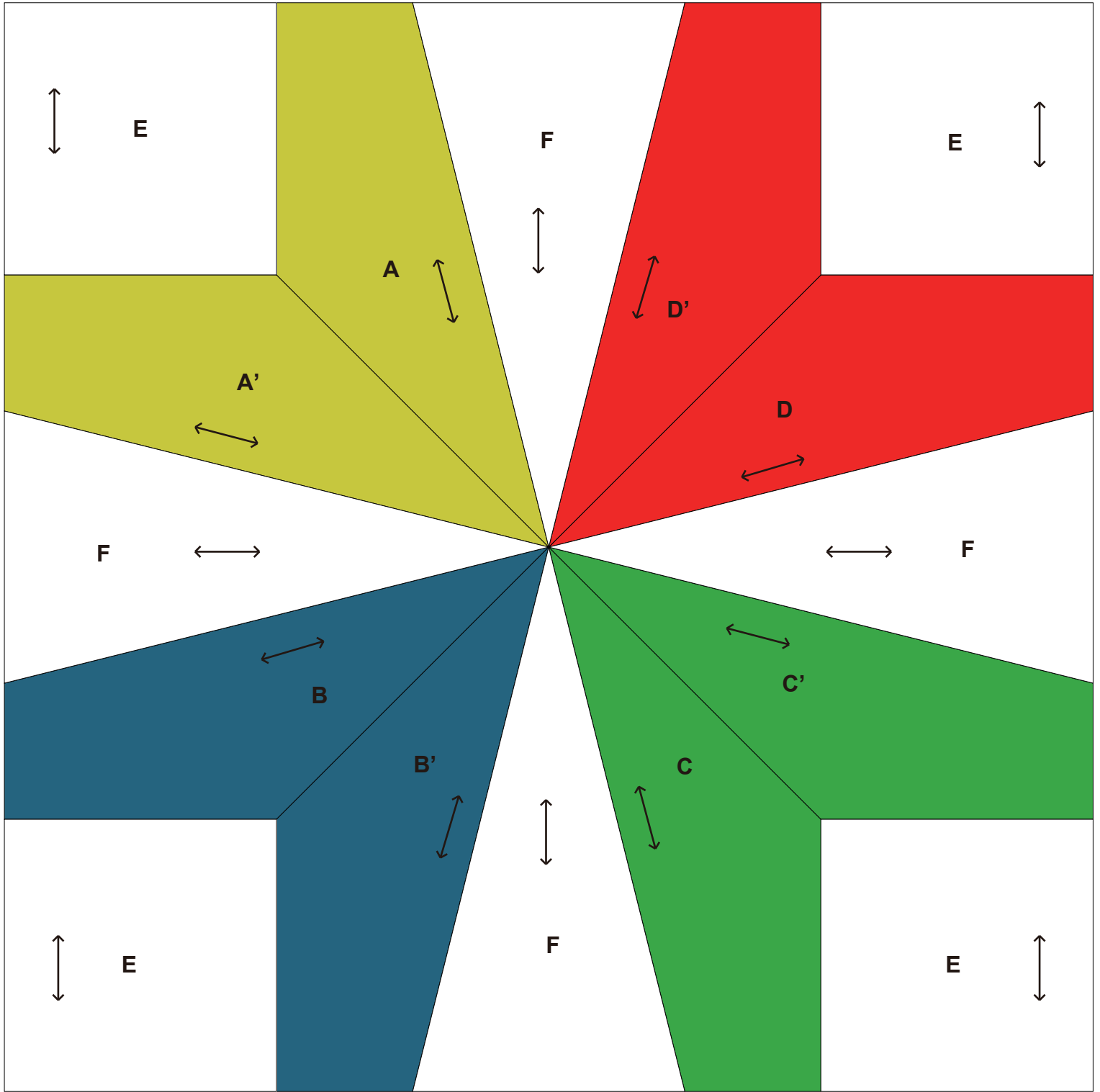

0 1 2 3 4 inches(")

0 50 100 mm

2

Four-leaf clover

Illustration of finished item

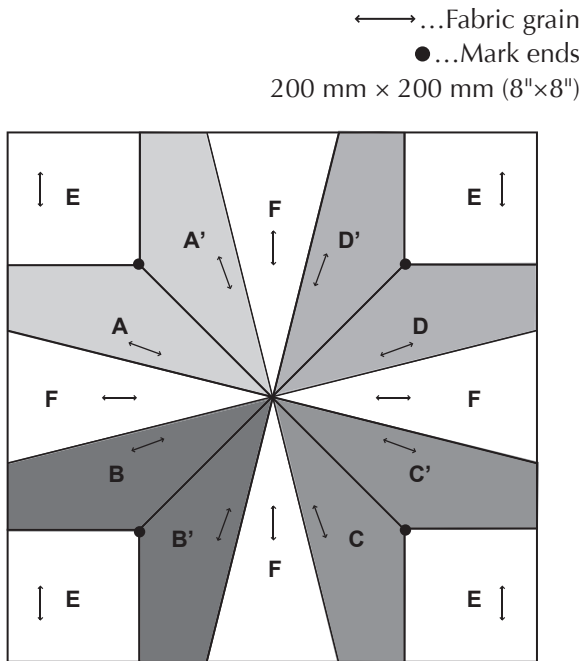

How to make

• Make blocks A, B, C and D

- 1 Taking care of the mark ends, sew together separately A and A', B and B', C and C', and D and D'.

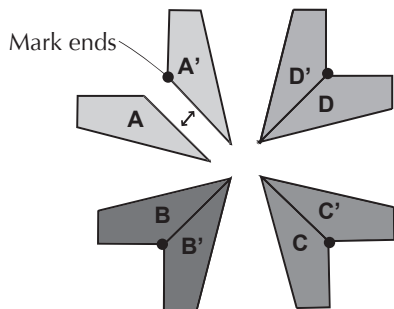

- 2 Make set-in seams E to A, B, C and D.

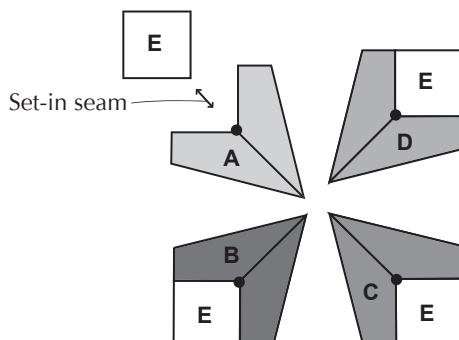

- 3 Sew on F.

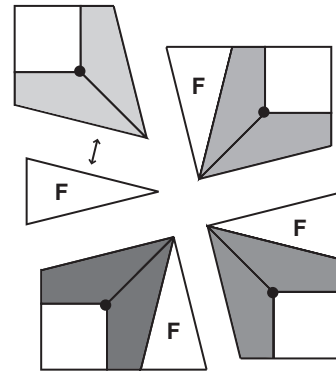

• Sew together the upper and lower blocks

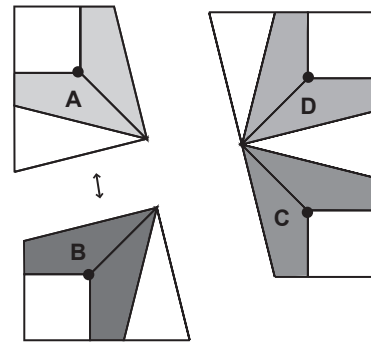

• Sew together the left and right blocks

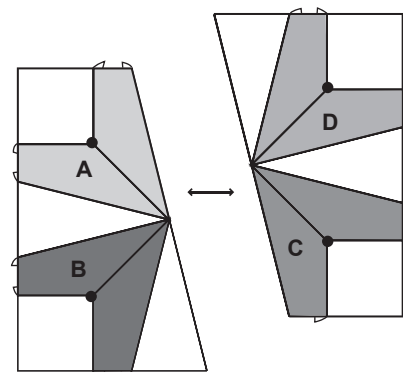

The task is completed.

3

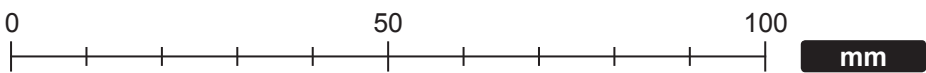
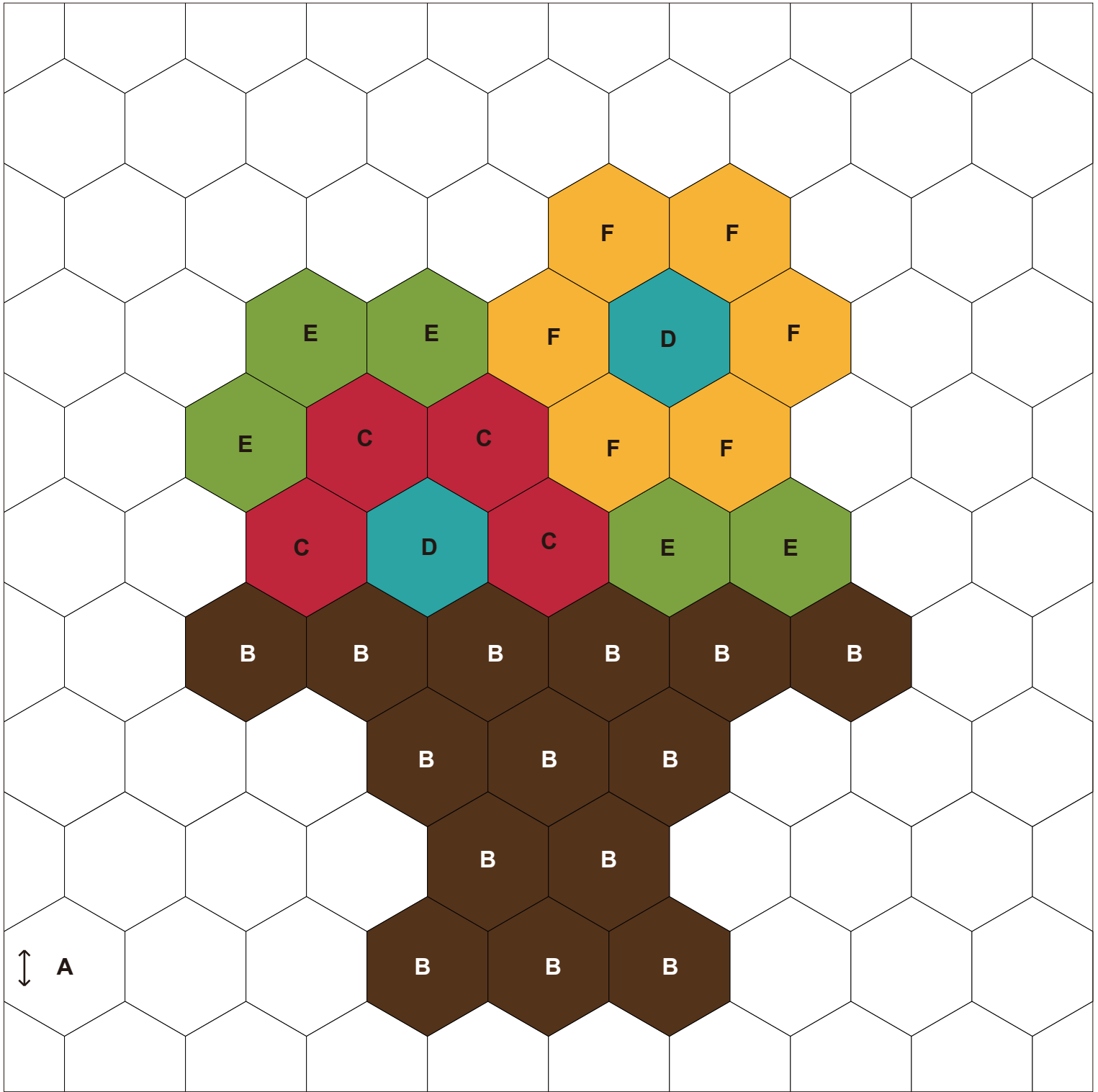

3 Flower-filled compote

Illustration of finished item

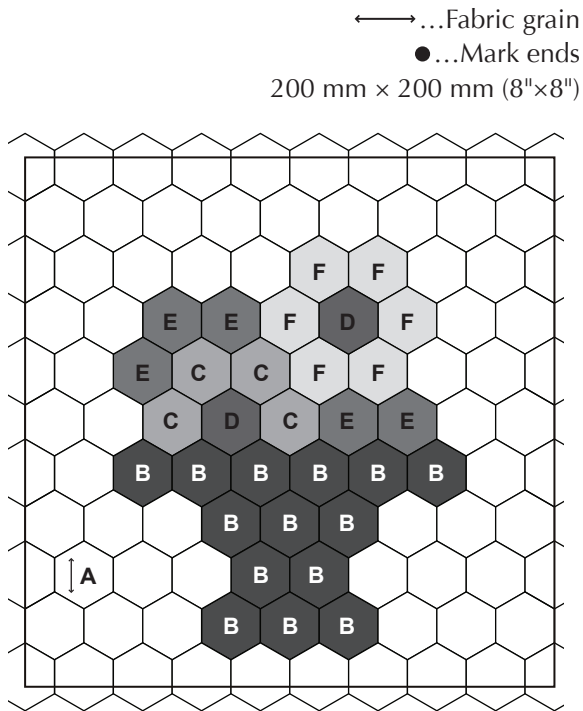

How to make

• Sew together the hexagonal pieces

- 1 Sew one side of the hexagonal pieces so that the line is made sideways, taking care of the mark ends.

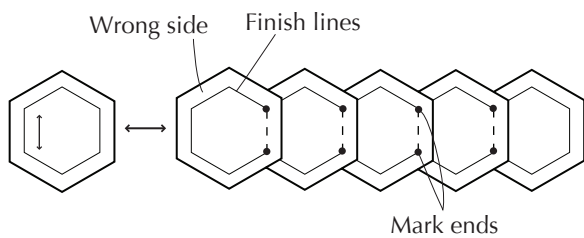

- 2 Make the set-in seams between rows, as shown in the figure.

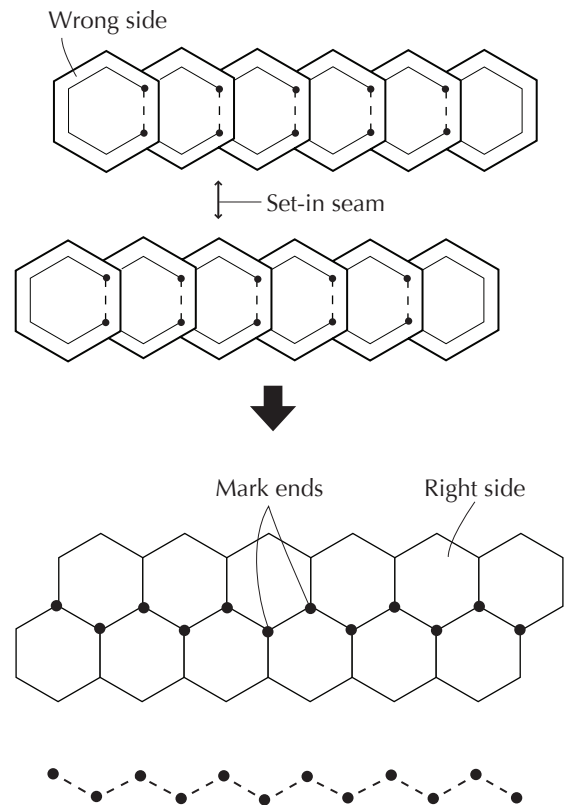

Note: Make set-in seams on mark ends

- 3 Fold over the seam allowance as shown in the figure, and then iron it.

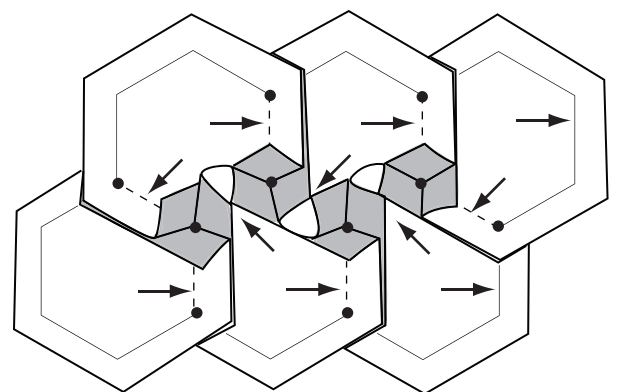

Note: Fold in the direction shown by the arrows.
Fold the overlapping seam allowances to look like a windmill.

The task is completed.

4

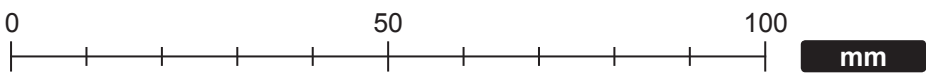
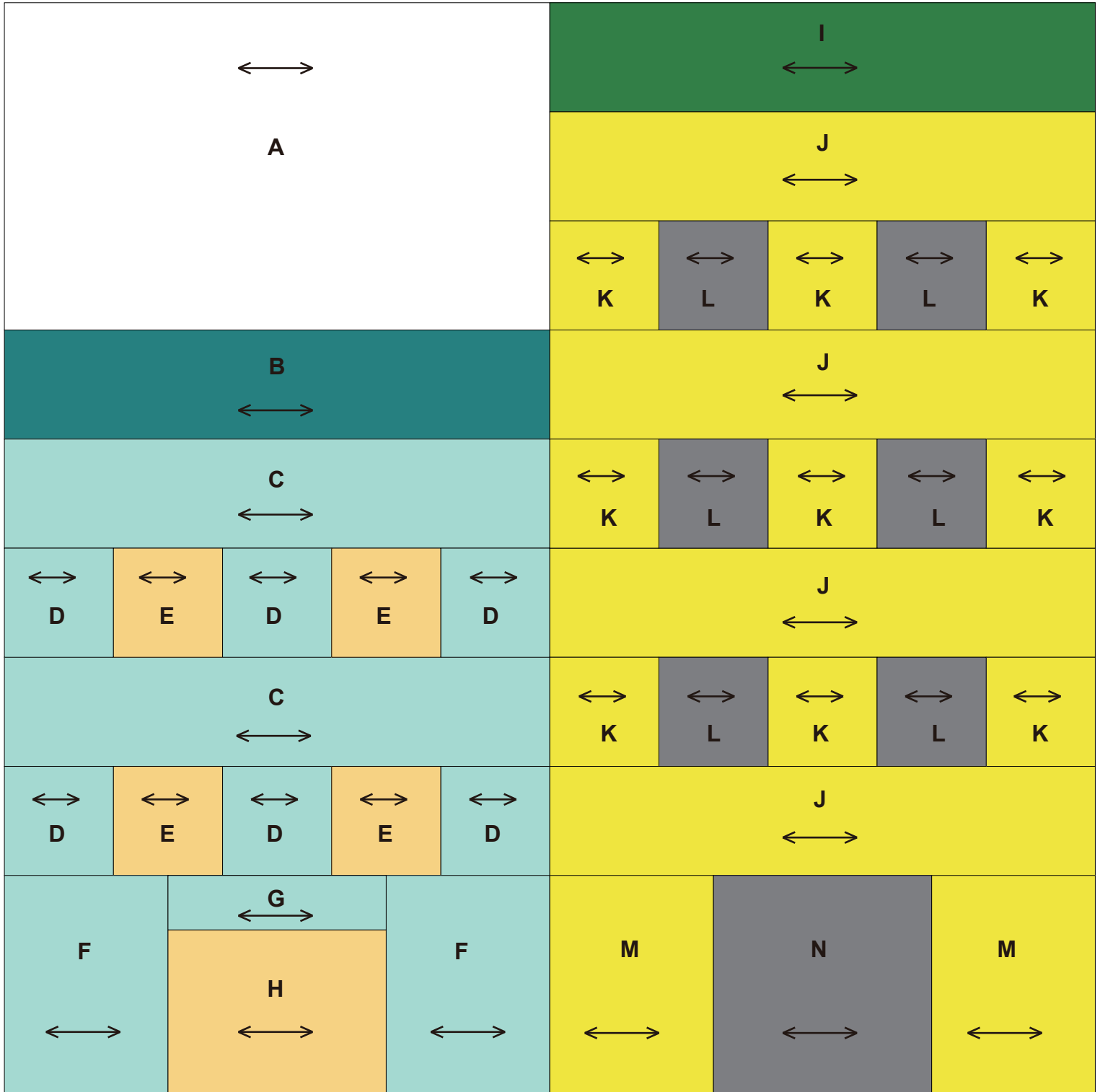

4

Buildings

Illustration of finished item

←...Fabric grain
200 mm × 200 mm (8"×8")

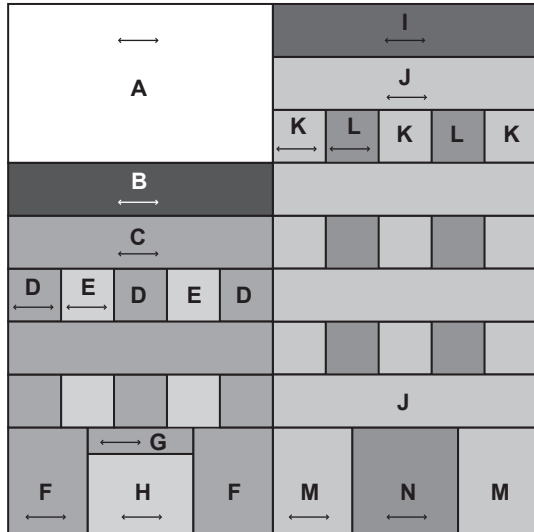

How to make

• Create a block of tall buildings

1 Stitch together **K** and **L** on the sides, and then sew on **J**. (Three pieces)

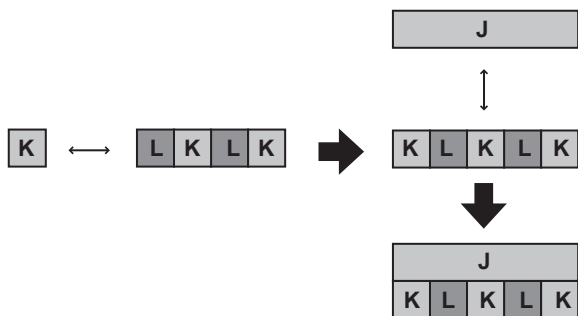

2 Stitch together **M** and **N** on the sides, and then sew on **J**.

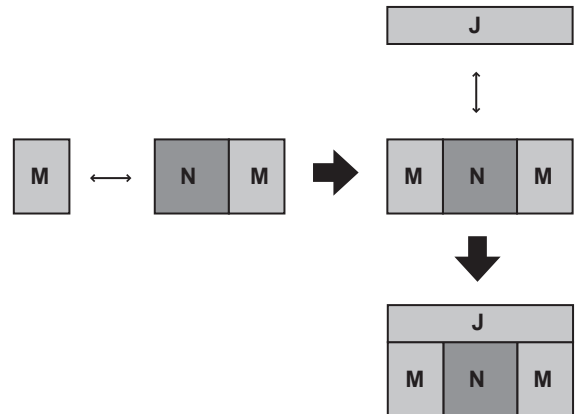

3 Align **I** with the overall design, and sew together.

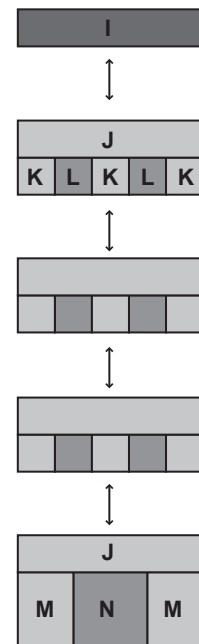

• Create a block of low buildings

1 Stitch together **D** and **E** on the sides, and then sew on **C**. (Two pieces)

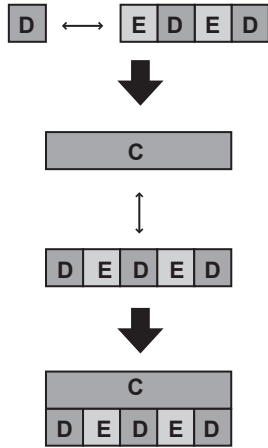

2 Stitch together **H** and **G** as shown in the figure, and then sew on **F**. (Two pieces)

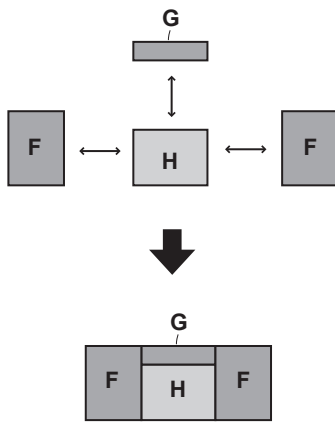

3 Stitch together **A** and **B** as shown in the figure, and then sew together the whole design.

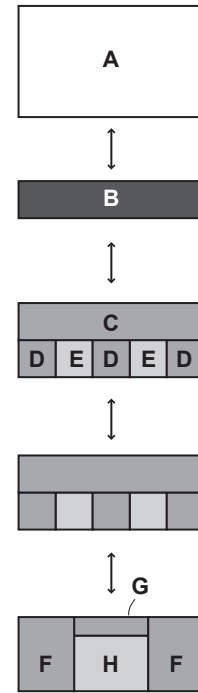

• Sew together the left and right blocks

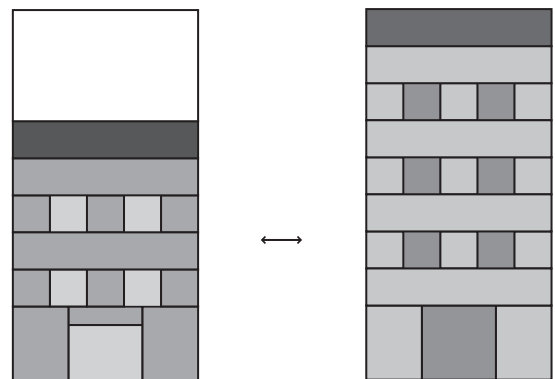

The task is completed.

5

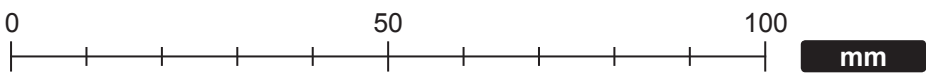
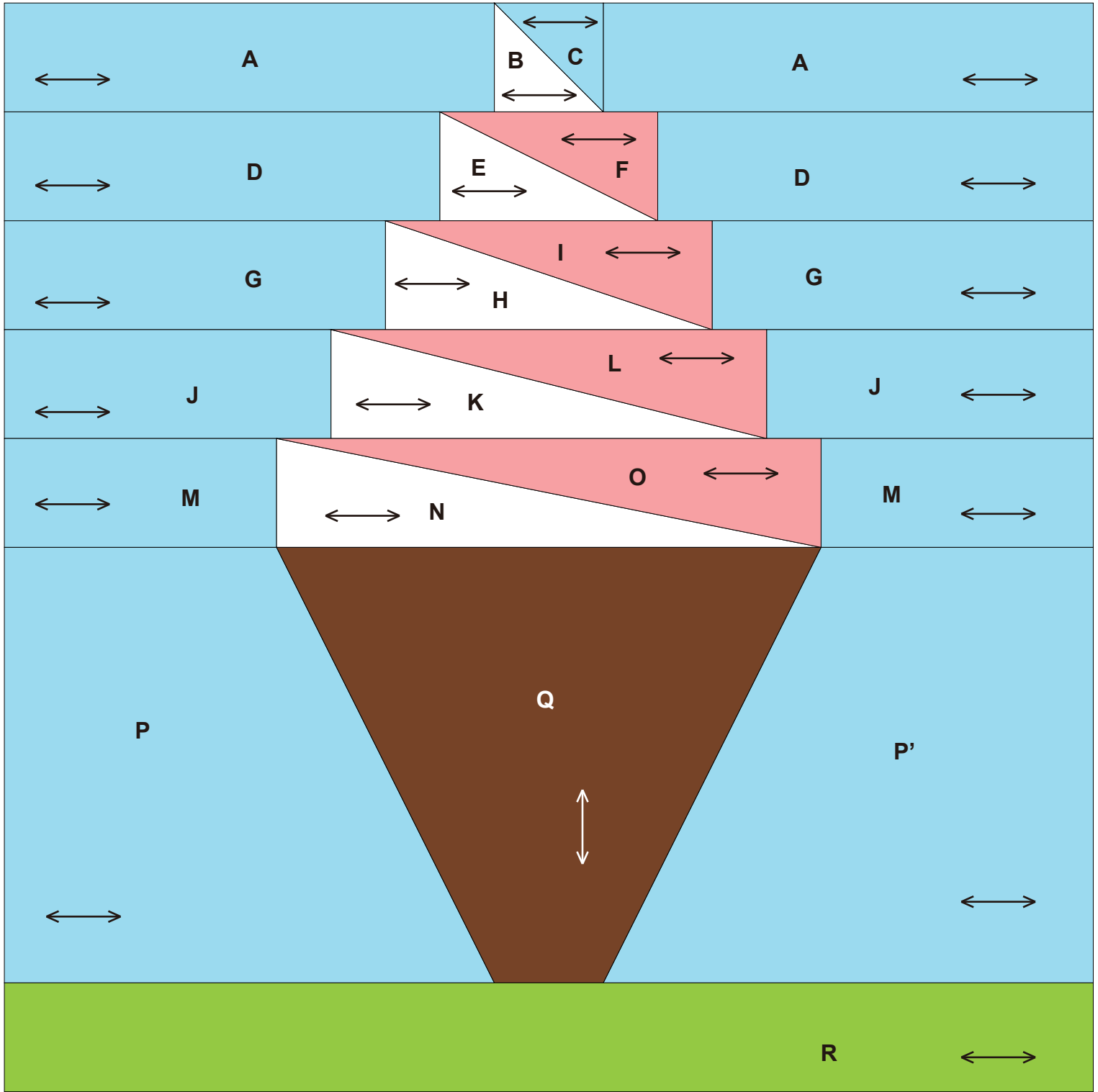

5

Ice cream cone

1/2

Illustration of finished item

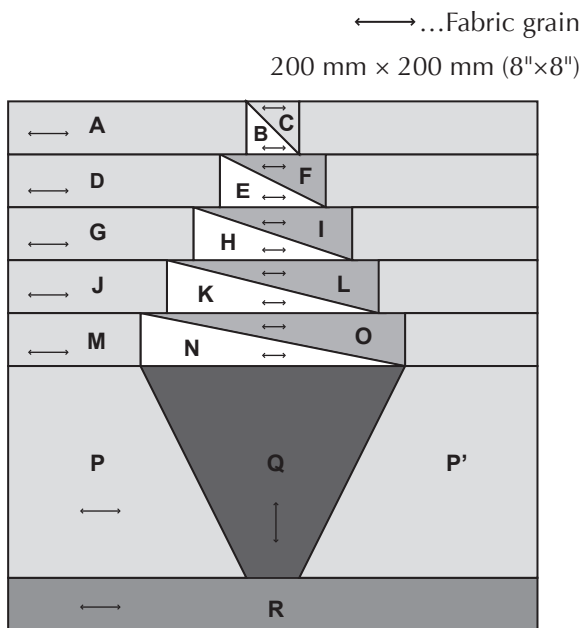

How to make

• Create ice cream blocks

1 Stitch together **B** and **C**, and then sew on **A**.

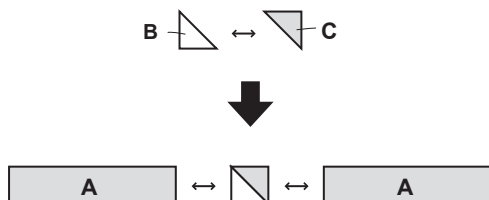

2 Stitch together **E** and **F**, and then sew on **D**.



3 Stitch together **H** and **I**, and then sew on **G**.



4 Stitch together **K** and **L**, and then sew on **J**.



5 Stitch together **N** and **O**, and then sew on **M**.



6 Sew together the overall design.

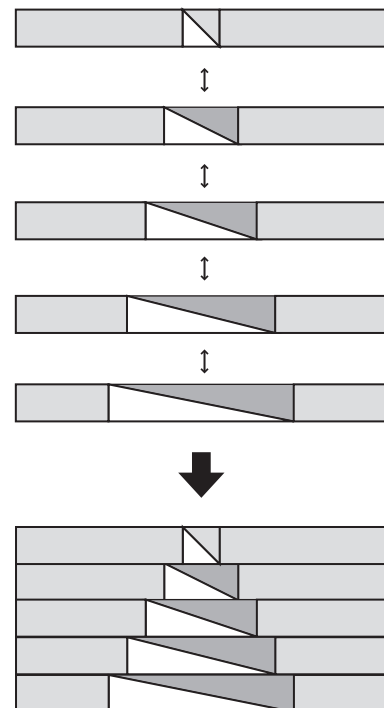

• Make the cone block

1 Stitch **P** and **P'** onto **Q**, and then sew on **R**.

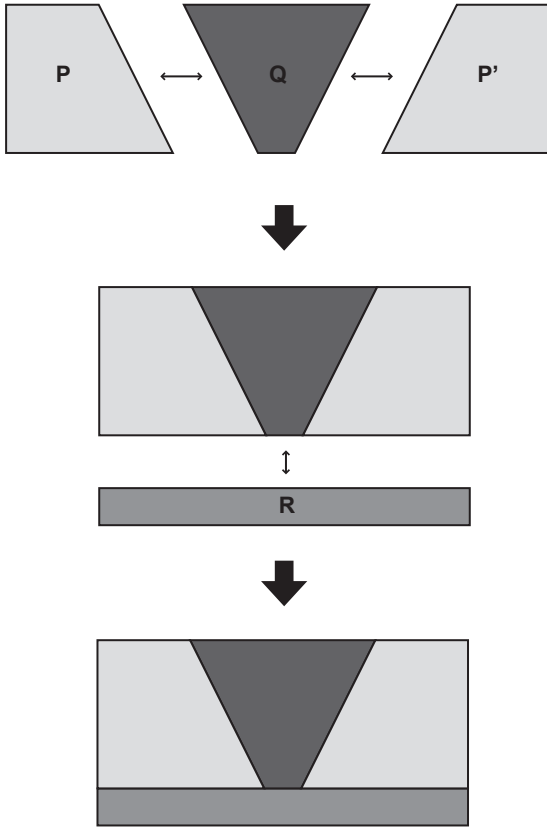

• Sew together the upper and lower blocks

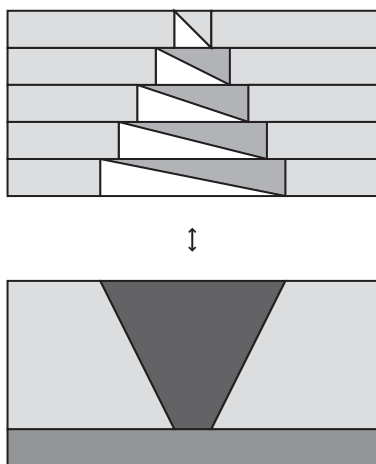

The task is completed.

6

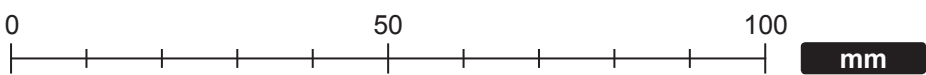
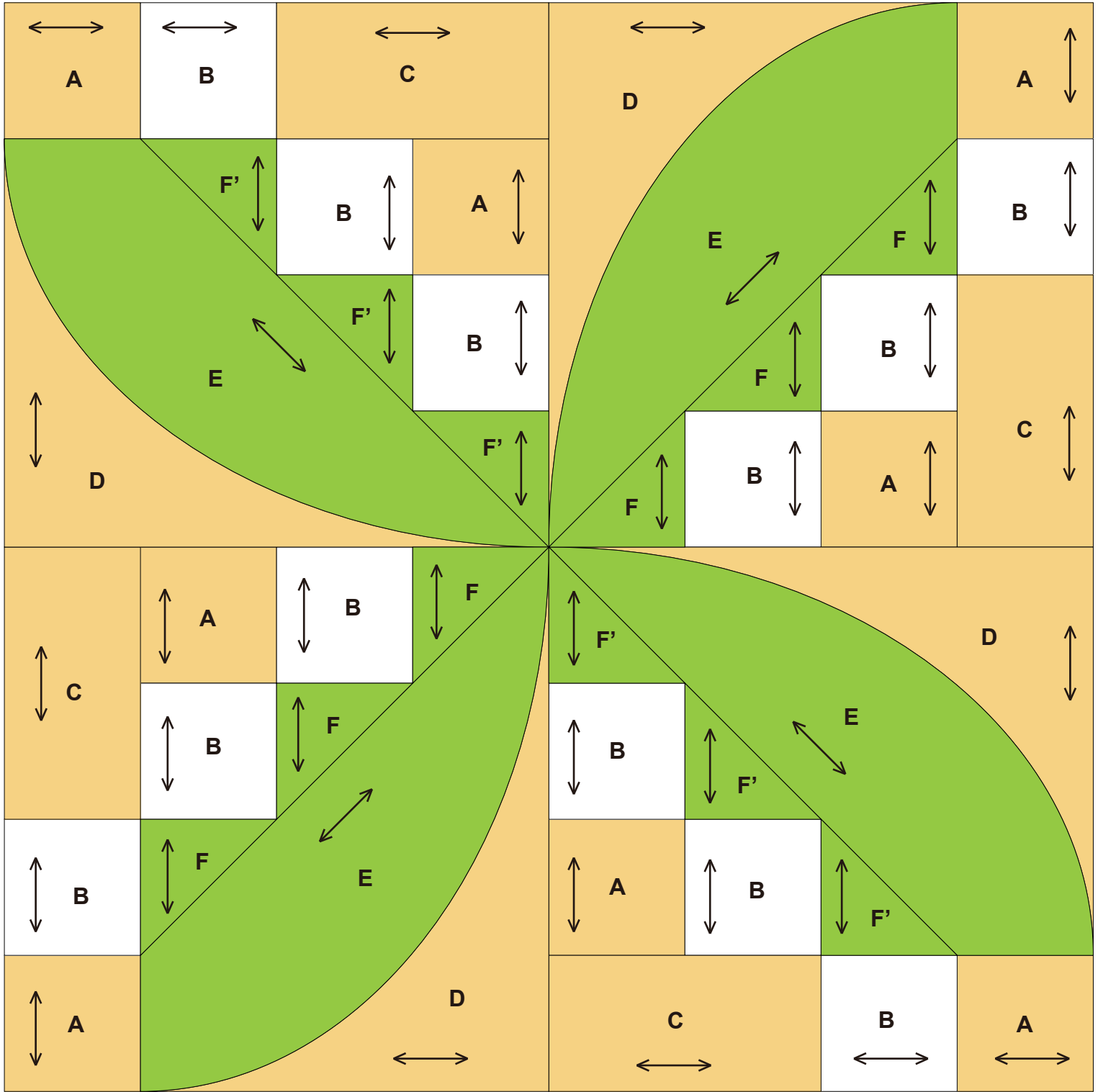

6 Lily of the valley

Illustration of finished item

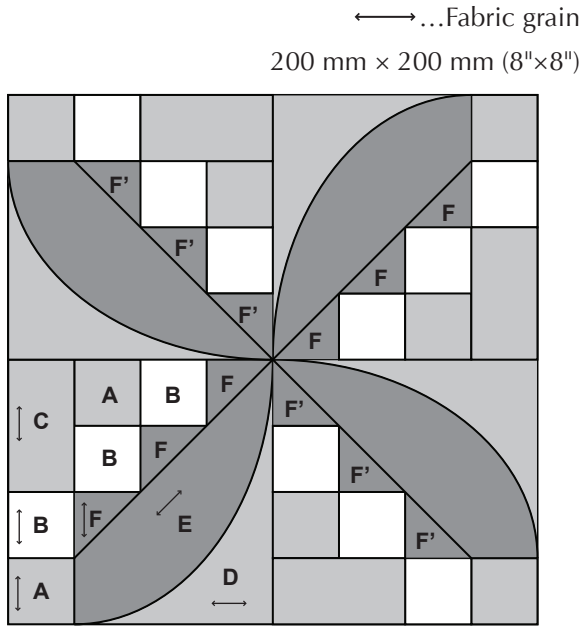

How to make

• Make lily of the valley blocks (four pieces)

1 Sew together C, B and A.

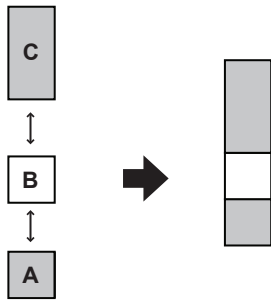

2 Sew on A, B and F, as shown in the figure.

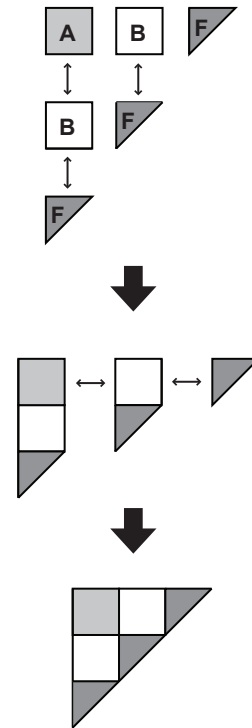

3 Sew together E and D. (The matching marks makes it easier to sew the pieces together.)

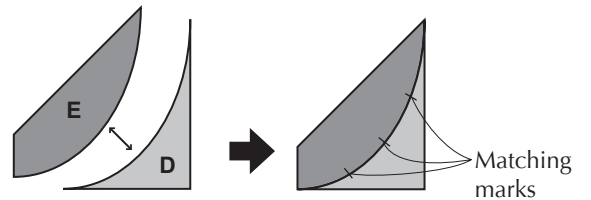

4 Sew together all the pieces, as shown in the figure.

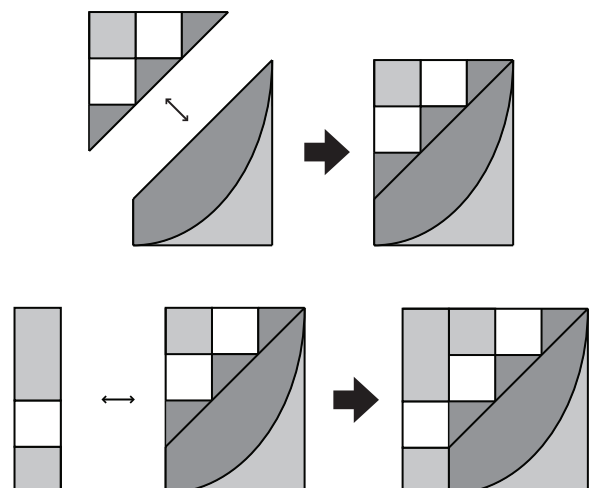

5 Make the other blocks in the same way, and sew them together by the sides.

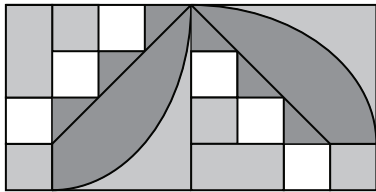
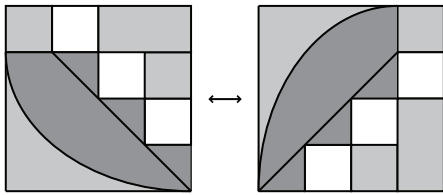

• Sew together the upper and lower blocks

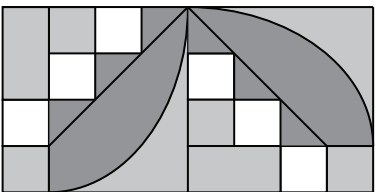
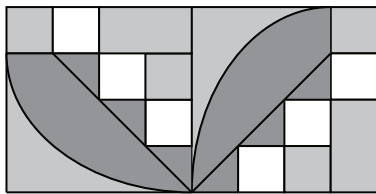

The task is completed.

7

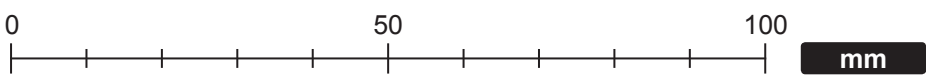
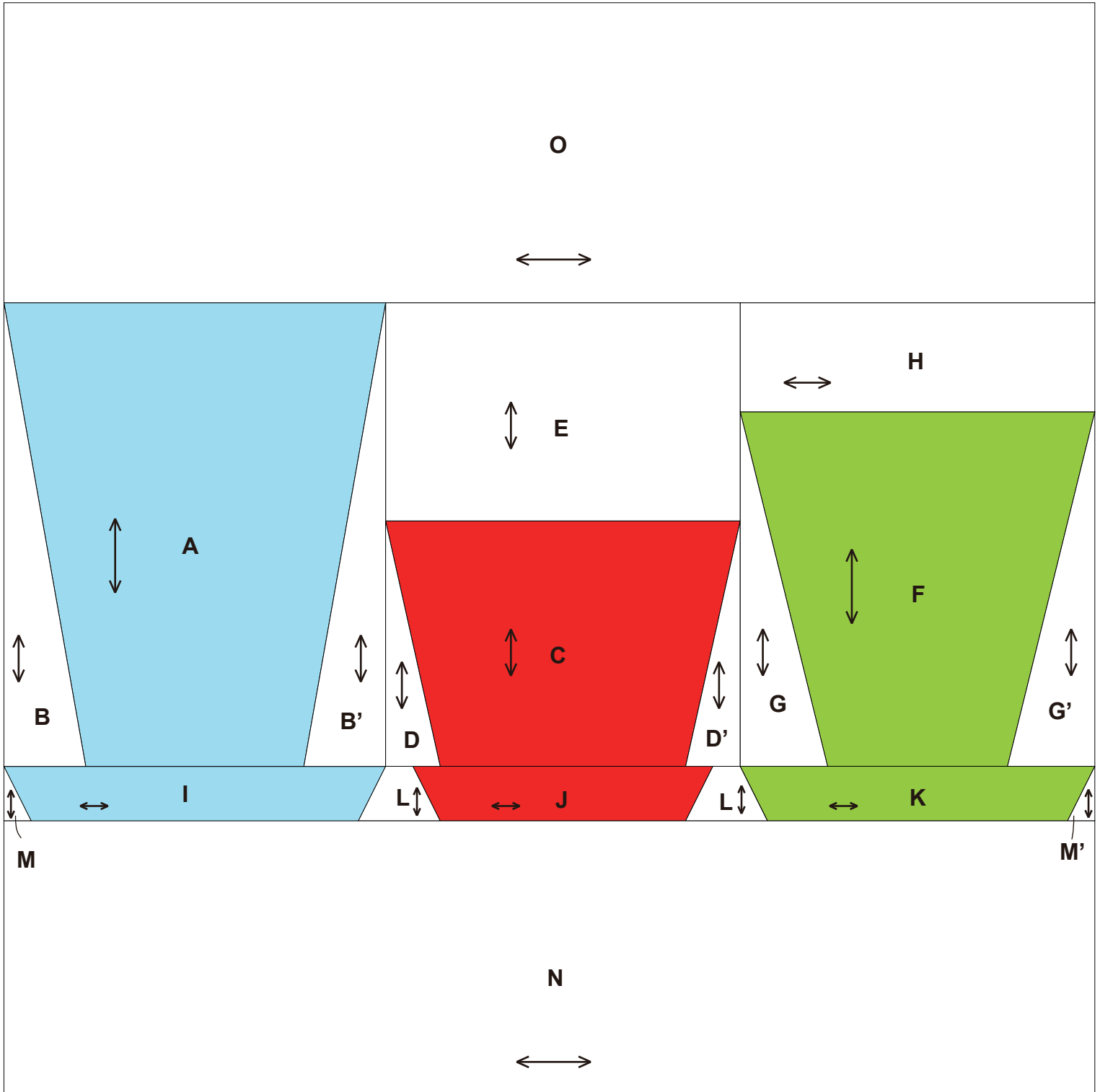

7

Cups and saucers

1/2

Illustration of finished item

←...Fabric grain

200 mm × 200 mm (8"×8")

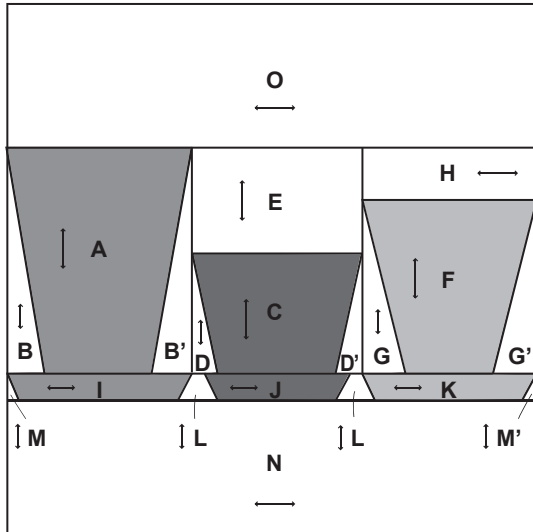

How to make

• Make the cup blocks

- 1 Sew together A, B and B'.

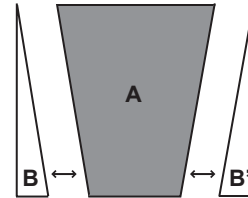

- 2 Stitch together C, D and D', and then sew on E.

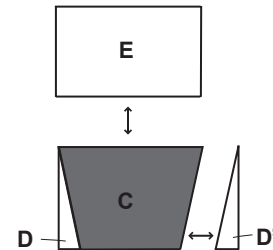

- 3 Stitch together F, G and G', and then sew on H.

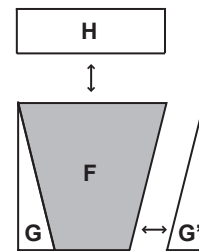

- 4 Sew together the overall design by the sides.

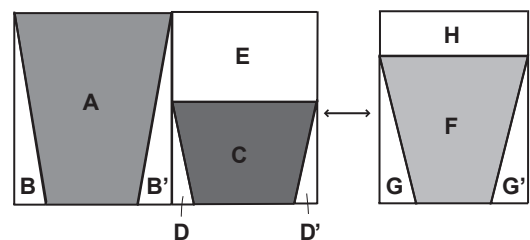

• **Make the saucer blocks**

1 Sew together I, J, K, L, M and M' by their sides.



• **Sew together the cup and saucer blocks**

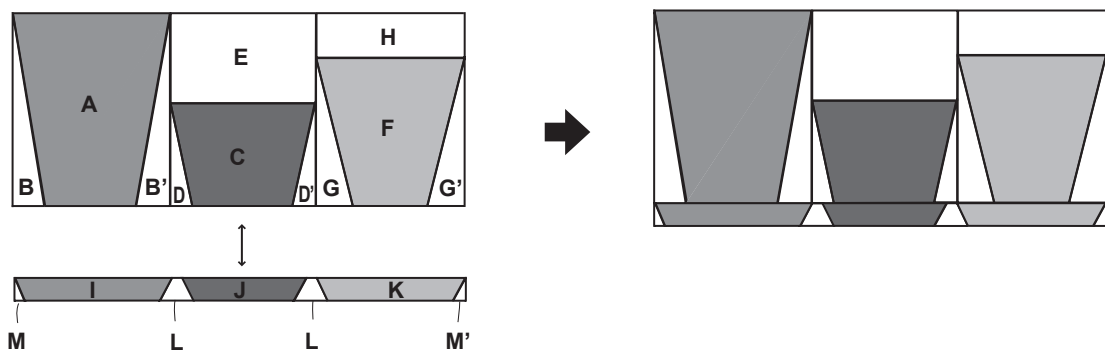

• **Sew together O and N**

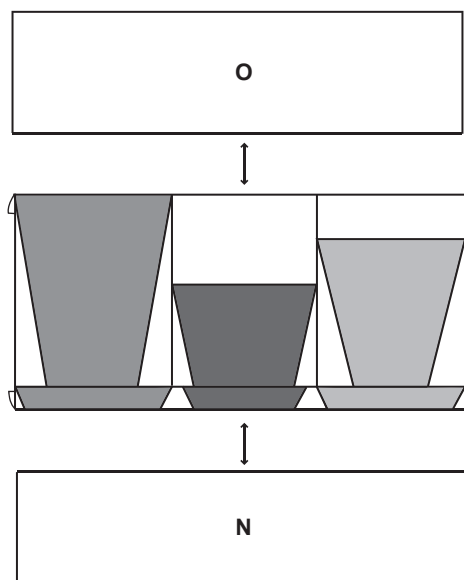

The task is completed.

8

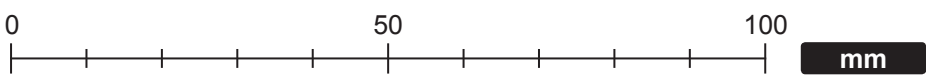
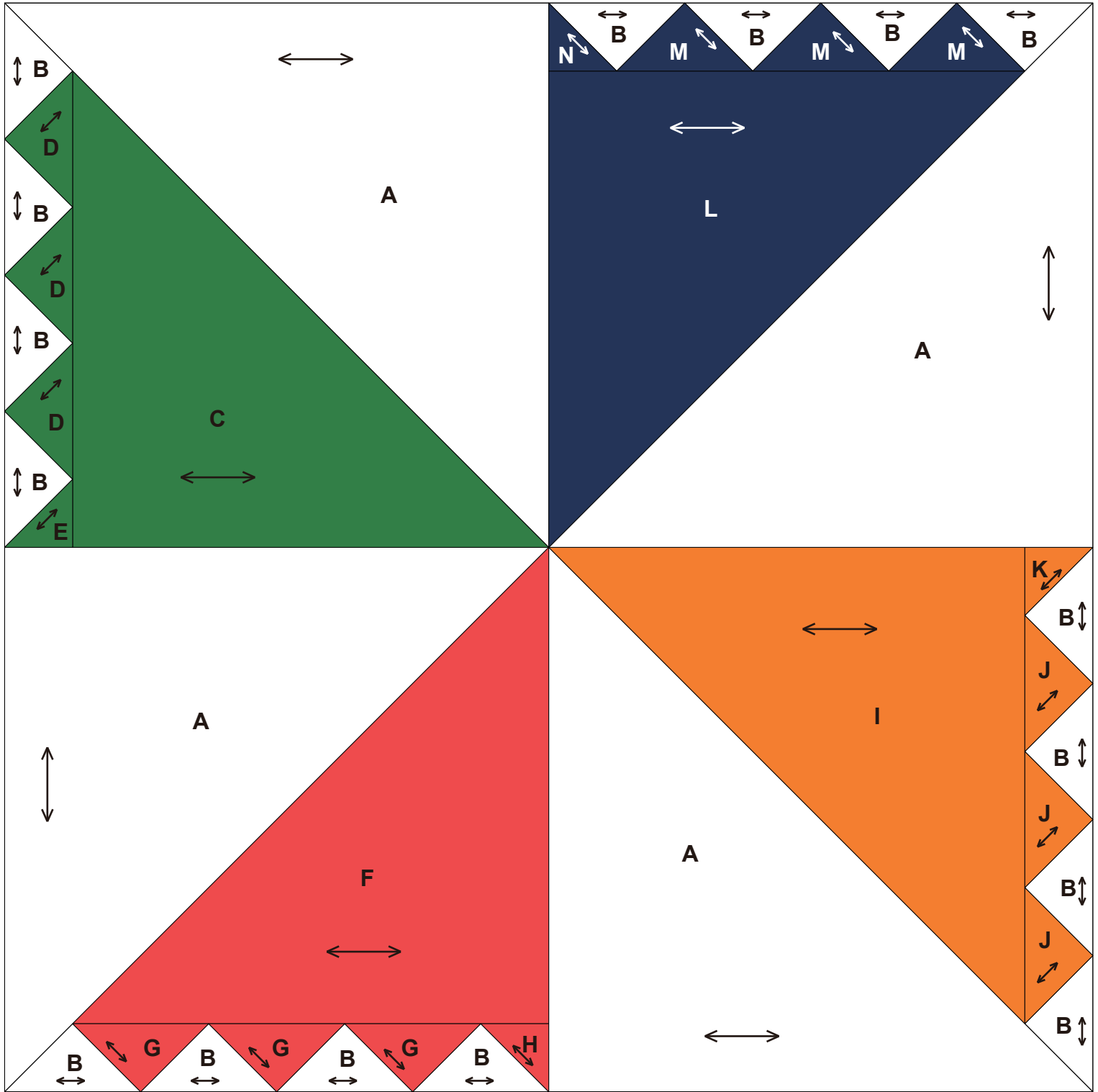

8

Saw teeth

1/2

Illustration of finished item

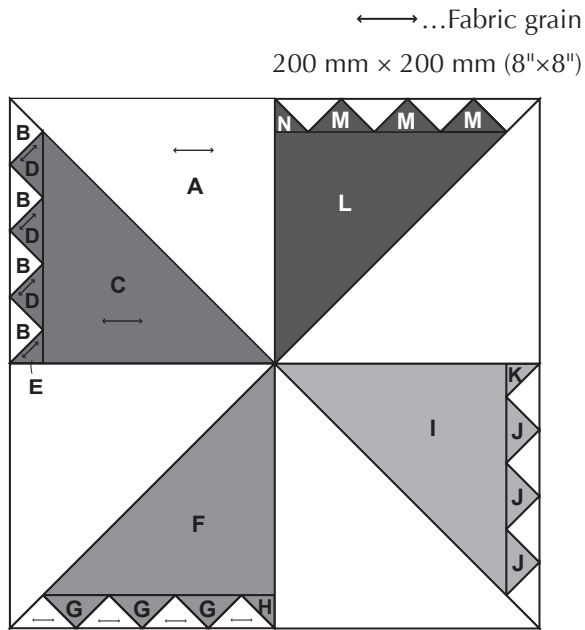

How to make

• Make saw teeth blocks (four pieces)

1 Sew together **B, D, E, G, H, J, K, M** and **N**, as shown in the figure.

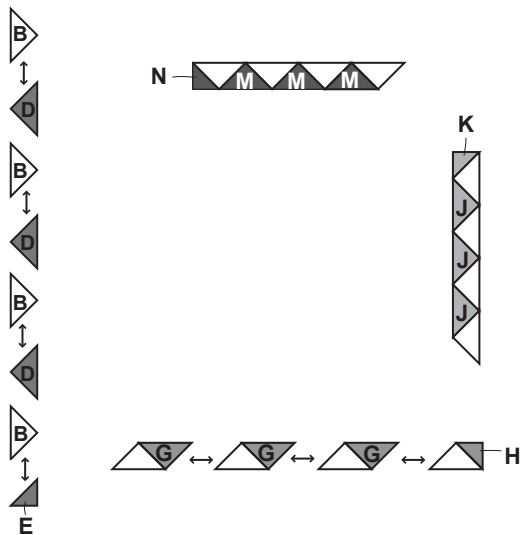

2 Sew together **C, F, I** and **L**.

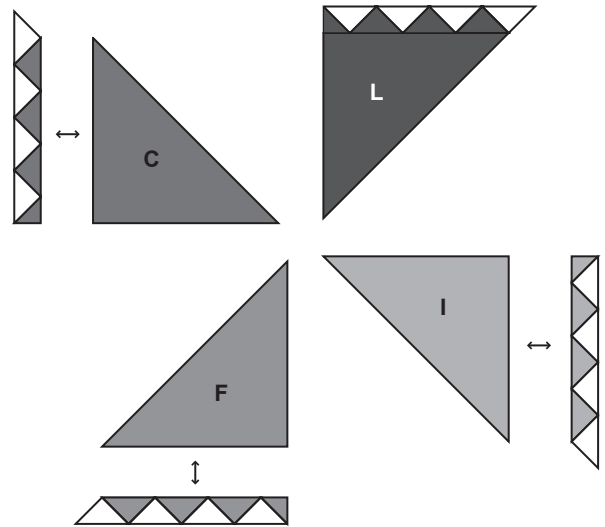

3 Sew the **A** sections onto the various blocks.

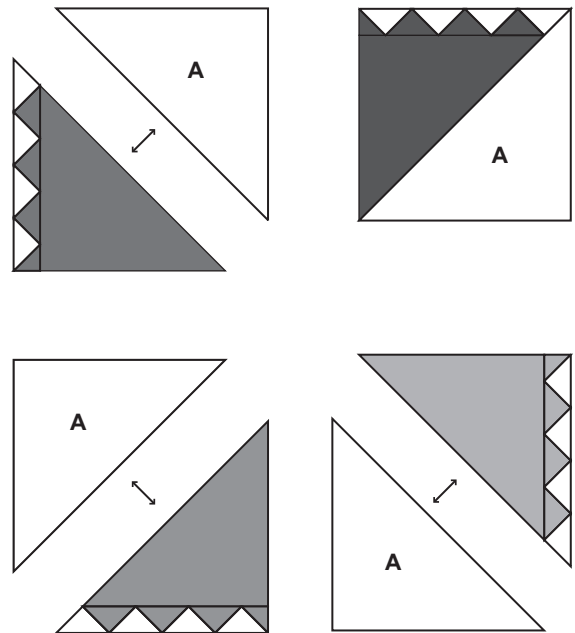

- Sew together the sides of the blocks

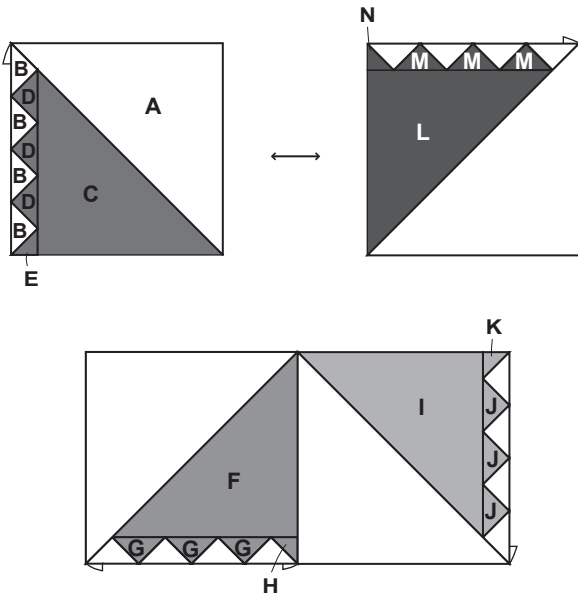

- Sew together the upper and lower blocks

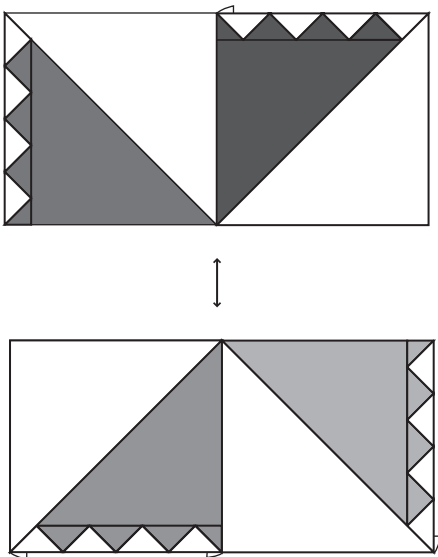

The task is completed.

9

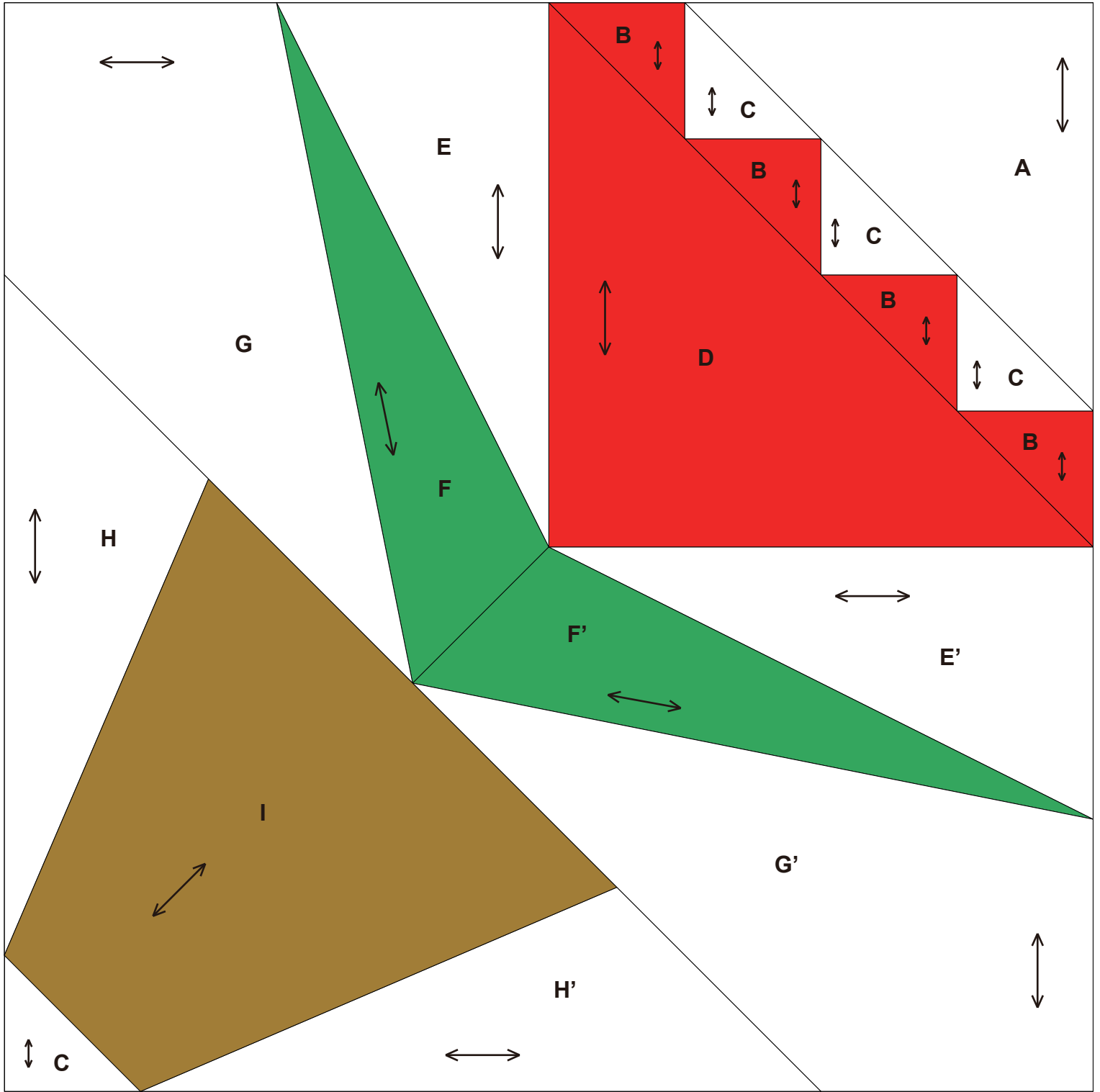

0 1 2 3 4 inches(")

0 50 100 mm

Illustration of finished item

←...Fabric grain
 ●...Mark ends
 200 mm × 200 mm (8"×8")

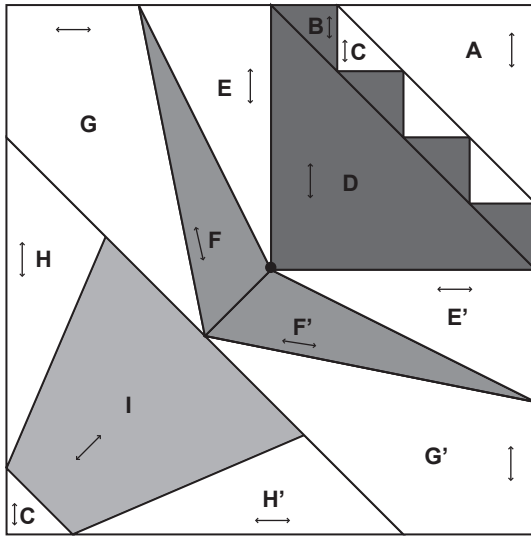

How to make

• Make the flower blocks

1 Sew together **B** and **C**.

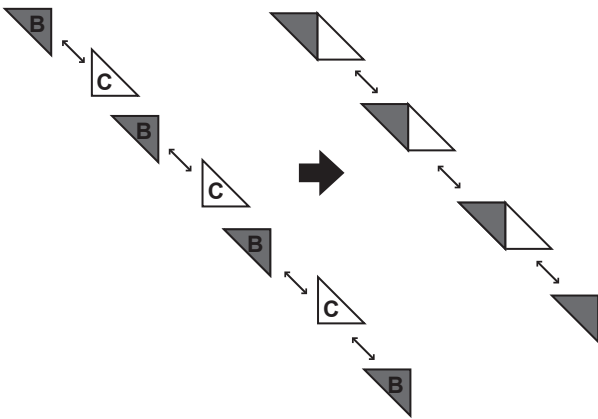

2 Sew on **A**.

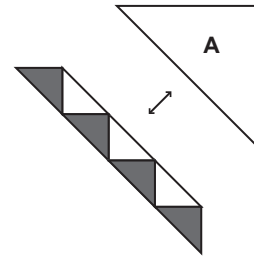

3 Sew on **D**.

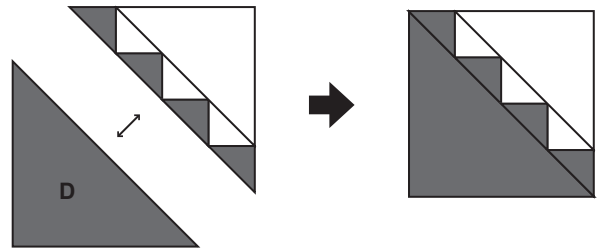

• Make the leaf block

1 Taking care of the mark ends, stitch together **E** and **F**, and then sew on **G**.

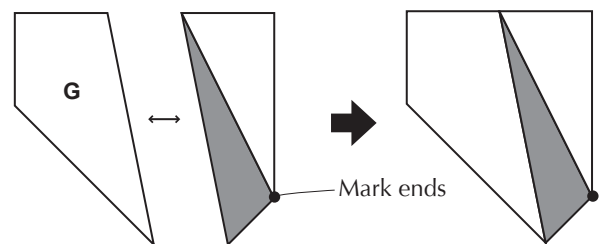
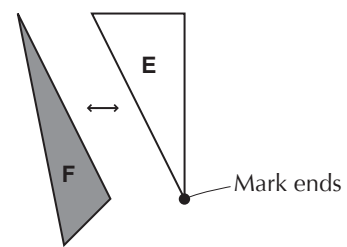

2 Also sew together symmetrical blocks E', F' and G' and, taking care of the mark ends, combine them as shown in the figure.

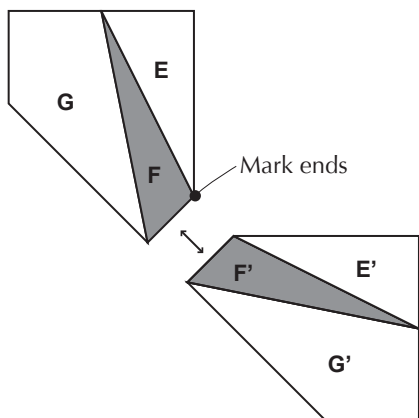

• Taking care of the mark ends on the flower and leaves blocks, make set-in seams

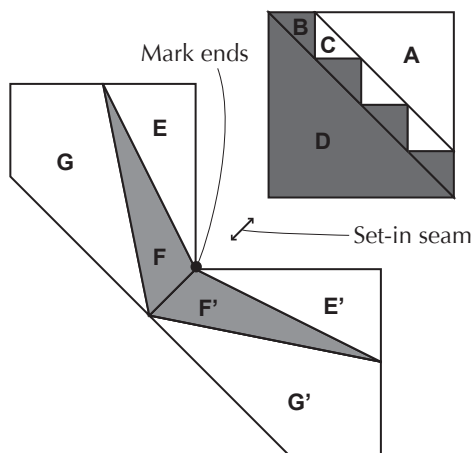

• Make the pot block

1 Sew together I, H and H'.

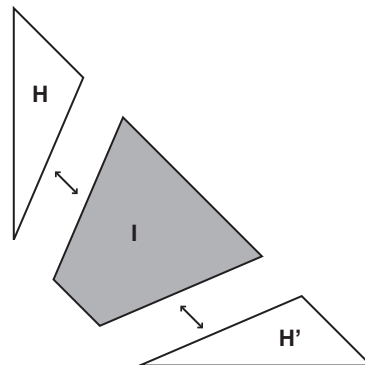

2 Sew on C.

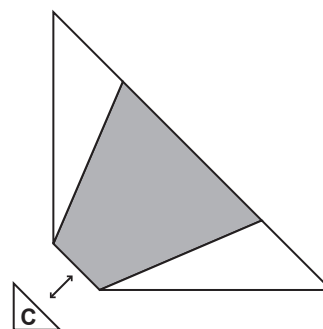

• Sew together the upper and lower blocks

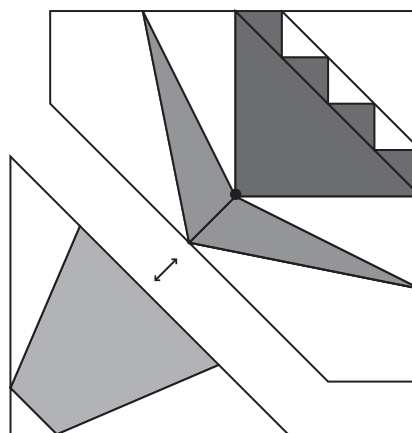

The task is completed.

10

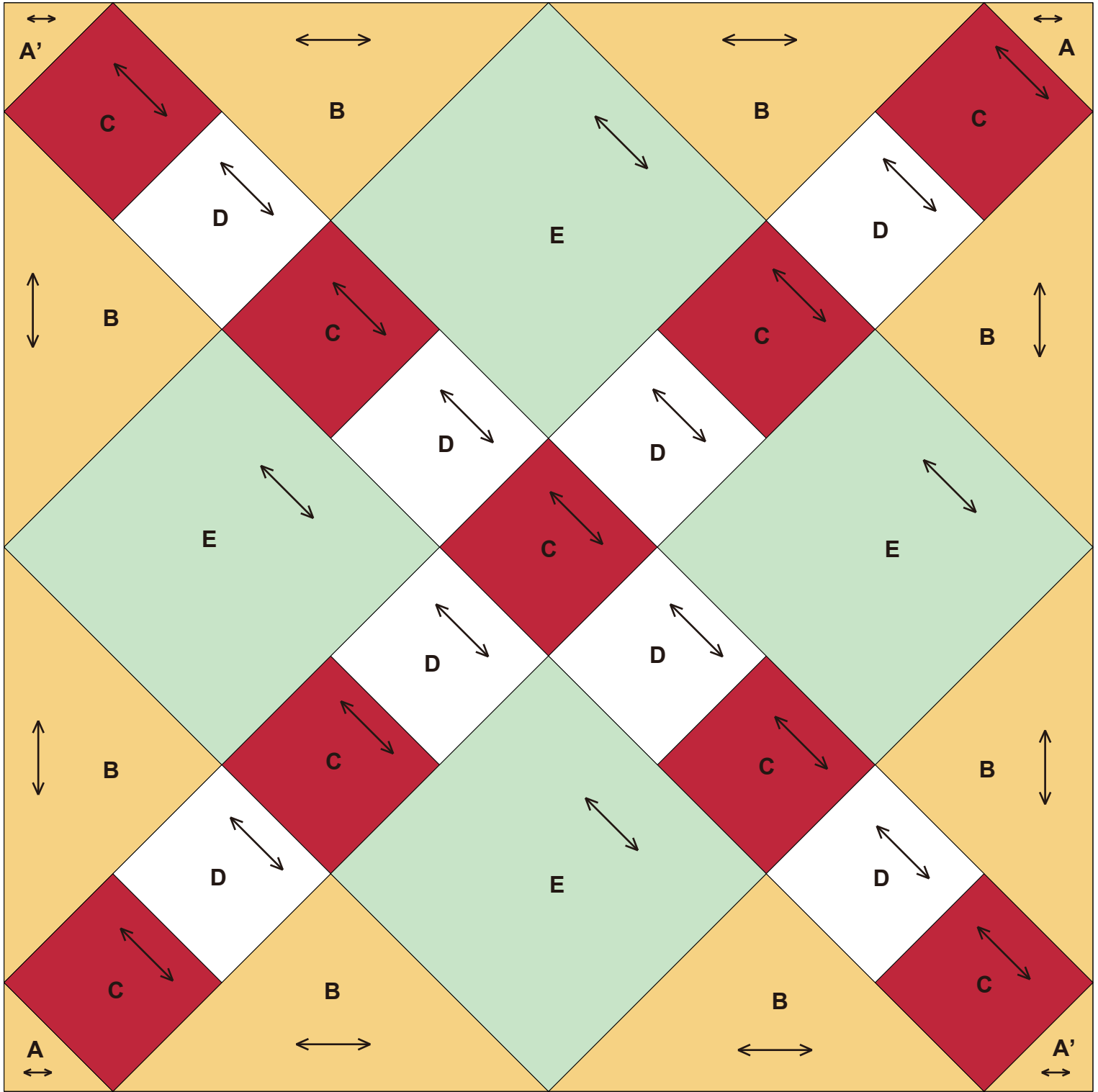

0 1 2 3 4 inches(")

0 50 100 mm

Illustration of finished item

←...Fabric grain
200 mm × 200 mm (8"×8")

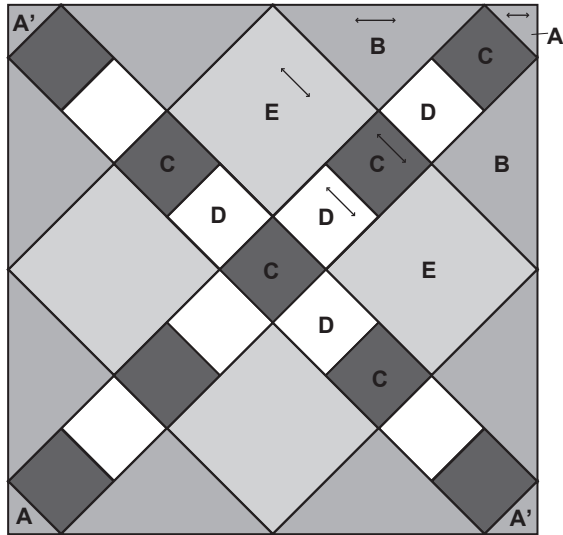

How to make

• Make the center block

- 1 Stitch together C and D, and then sew on E. (Two pieces)

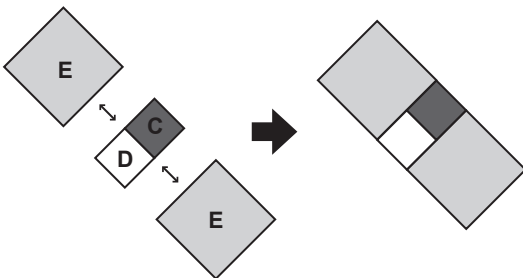

- 2 Sew together the central C and D pieces.

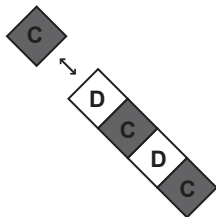

- 3 Sew together the overall design.

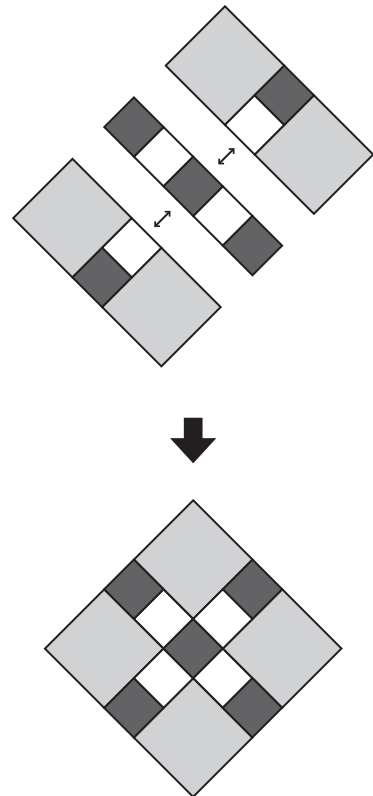

• Make angle blocks (four pieces)

- 1 Stitch together C and D, and then sew on B.

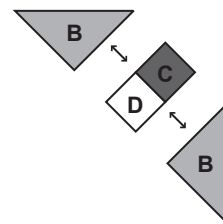

- 2 Sew on A.

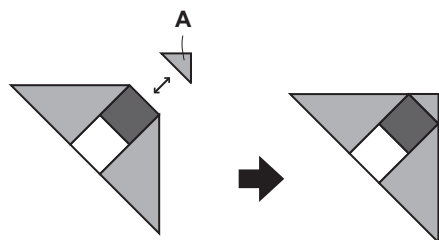

- Sew together the center and angle blocks, as shown in the figure
-

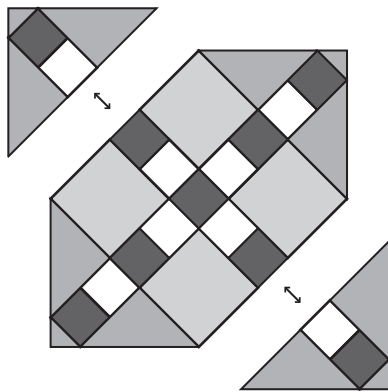

The task is completed.

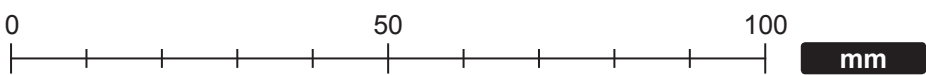
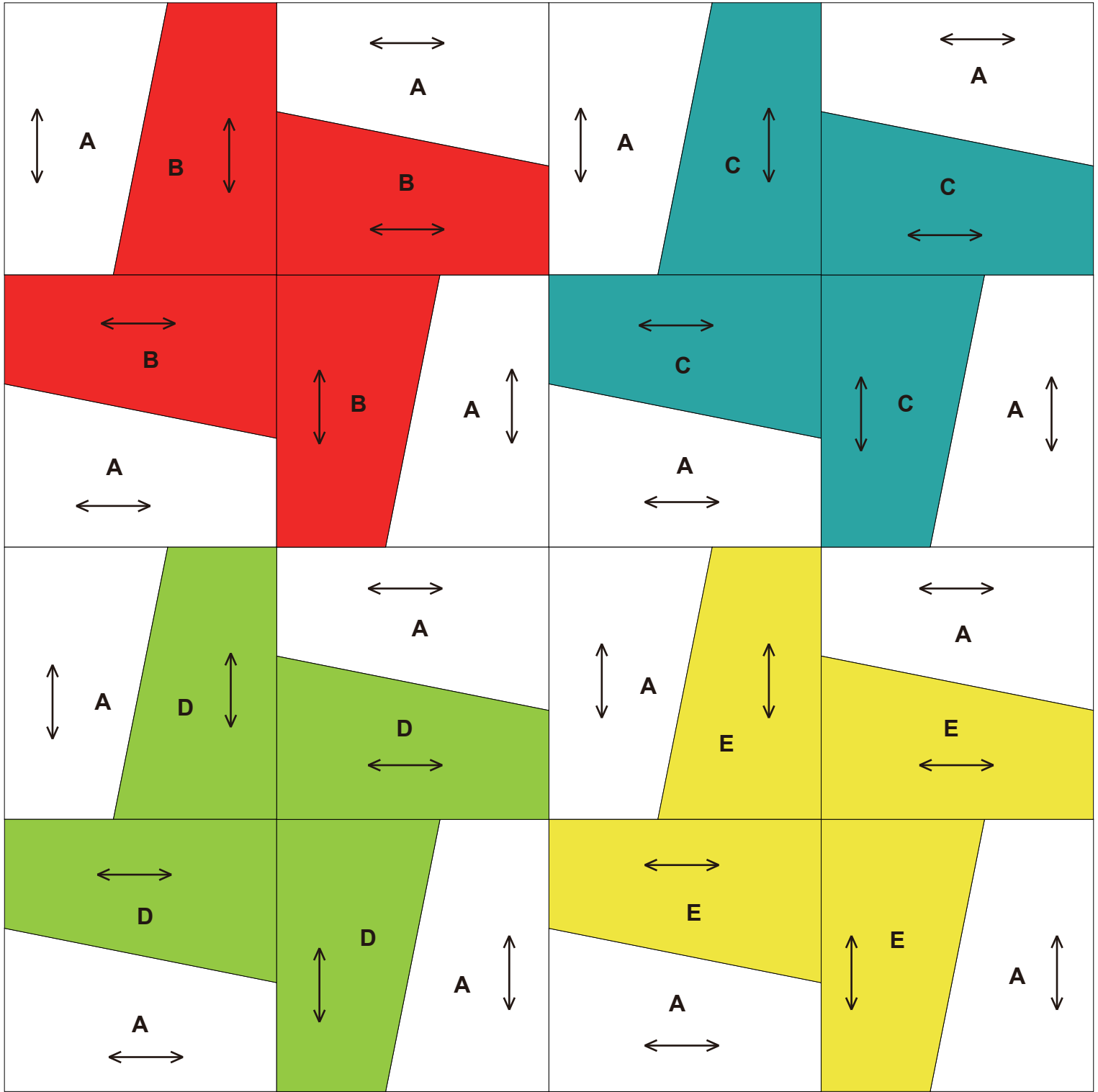

11

Windmill

Illustration of finished item

←...Fabric grain
200 mm × 200 mm (8"×8")

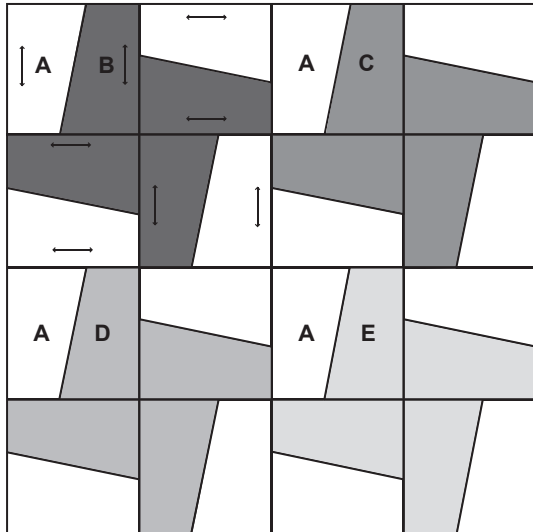

How to make

- Make windmill blocks (four pieces)

1 Sew together A and B.

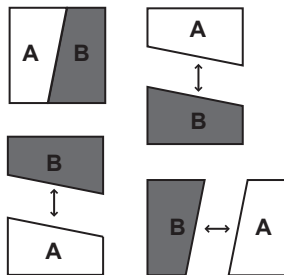

2 Sew together the windmill, as shown in the figure.

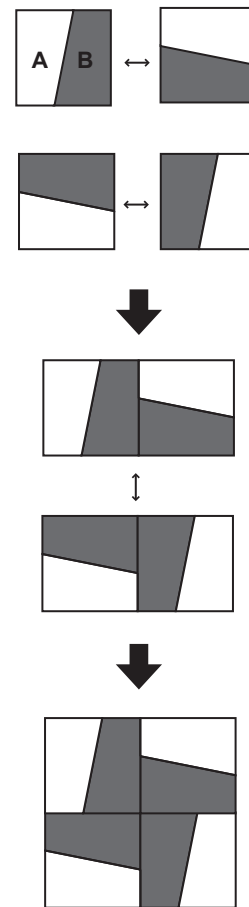

3 As with A and B, sew on [A and C], [A and D] and [A and E] to make the windmill.

- Sew together the sides of the blocks

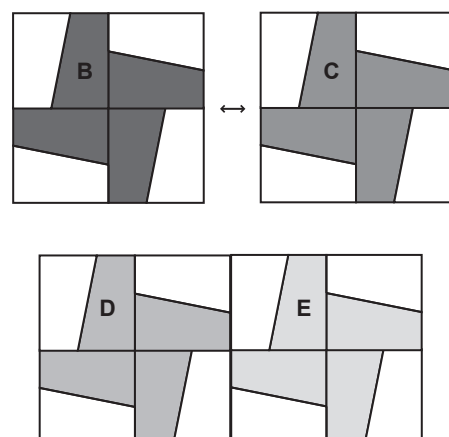

- Sew together the upper and lower blocks

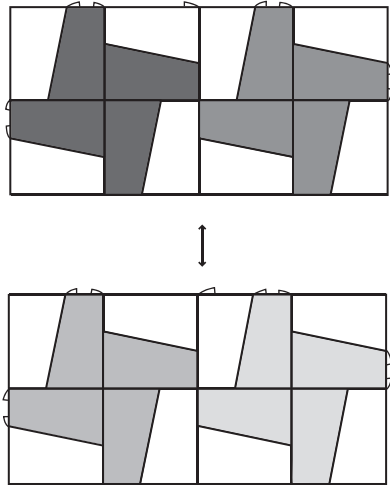

The task is completed.

12 One-way traffic

Illustration of finished item

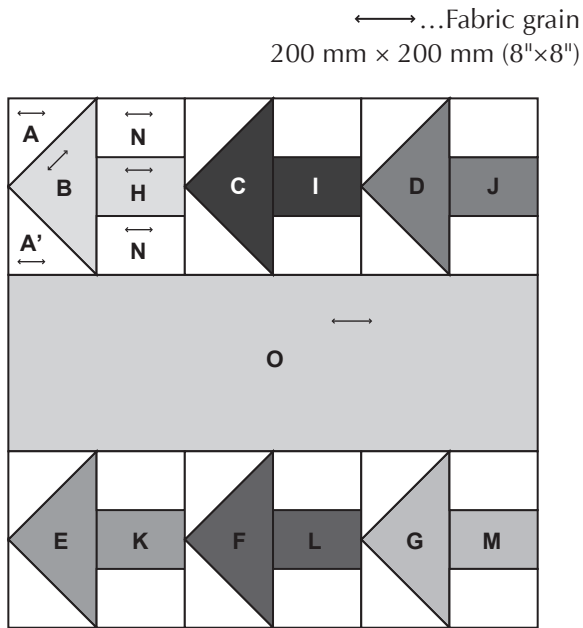

How to make

• Make arrow blocks (six pieces)

1 Sew together A, A' and B.

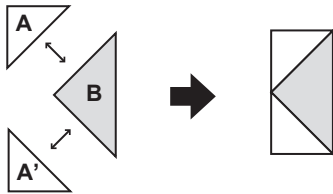

2 Sew together H, N and N'.

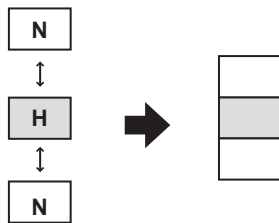

3 Sew together the left and right blocks.

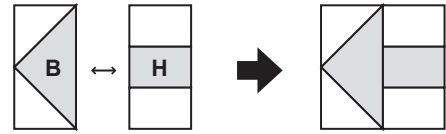

4 Make the other arrow blocks in the same way.

• Sew together the sides of the arrow blocks

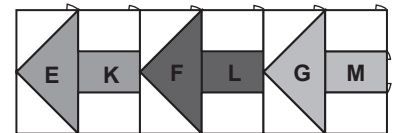
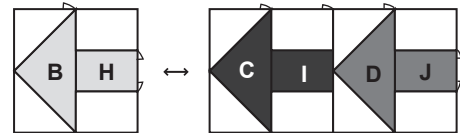

• Sew O on vertically

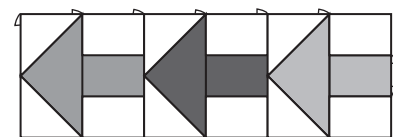
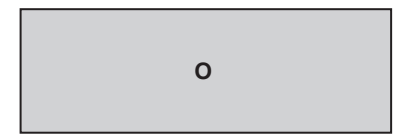
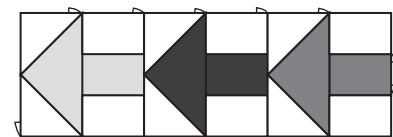

The task is completed.

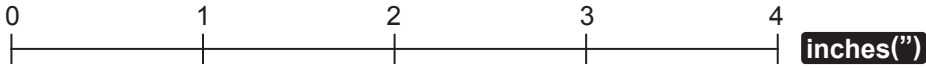
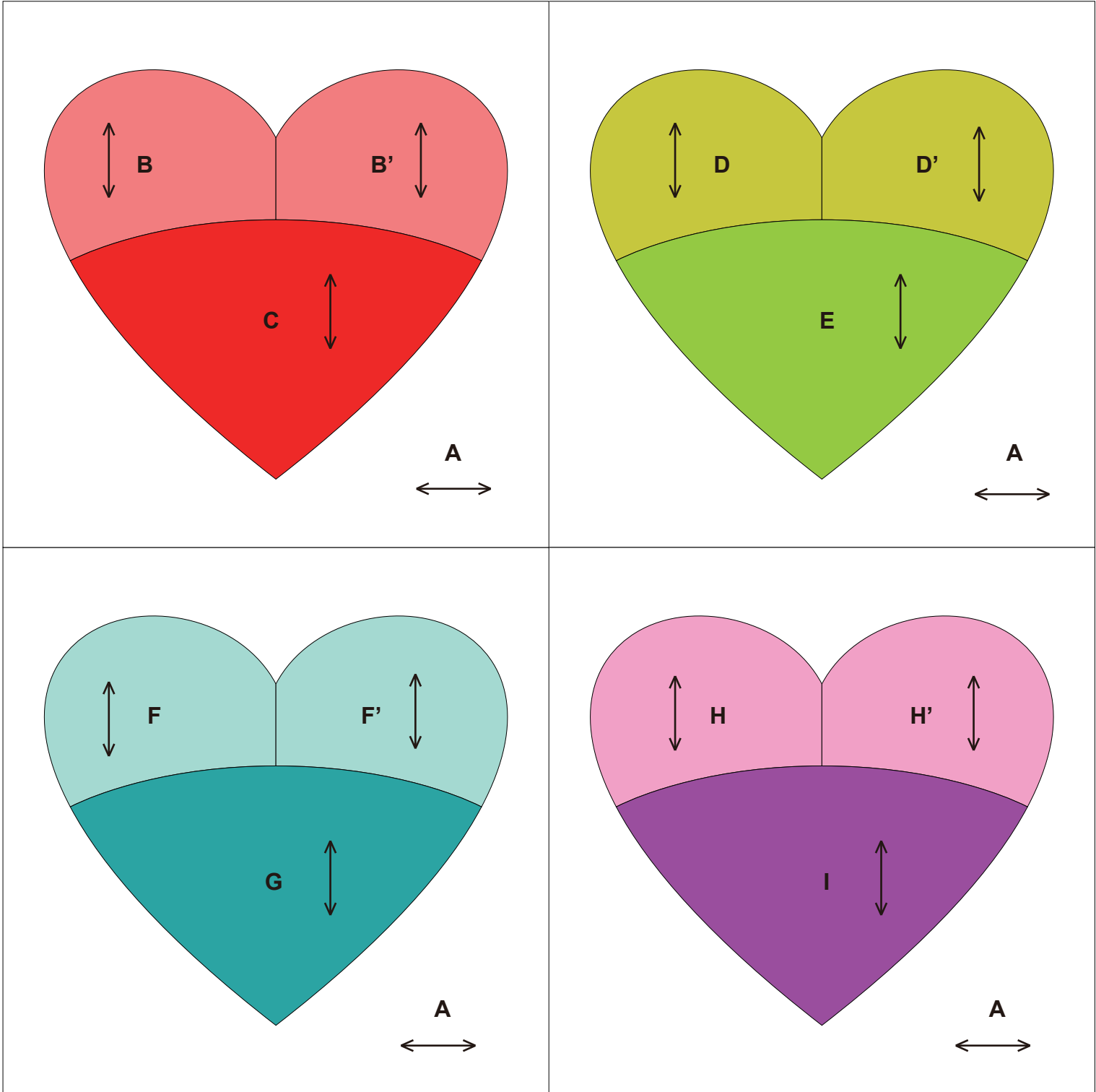
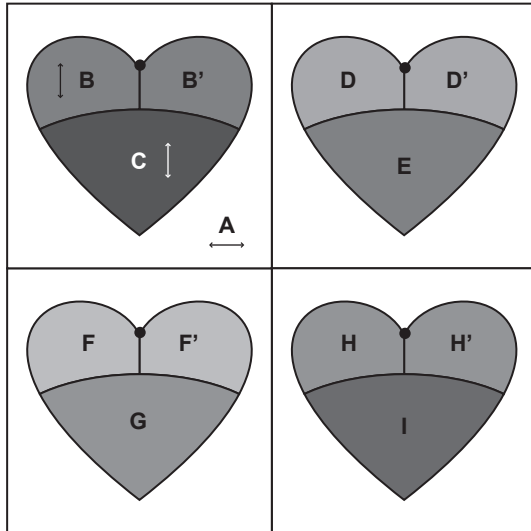

Illustration of finished item

←...Fabric grain
 ●...Mark ends
 200 mm × 200 mm (8"×8")



How to make

• Make the heart appliqués (four pieces)

1 Stitch **B** and **B'** together, taking care of the mark ends. Open seam allowances on the left and right.

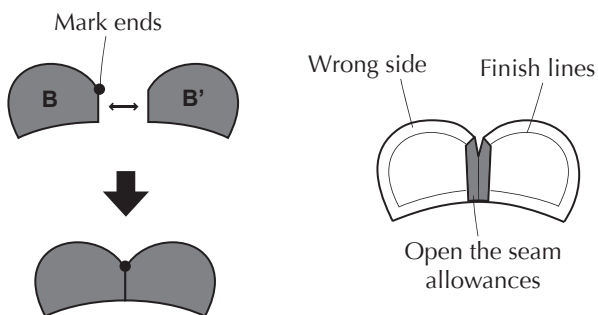

2 Sew on **C**, and make the hearts. Fold over the seam allowances.

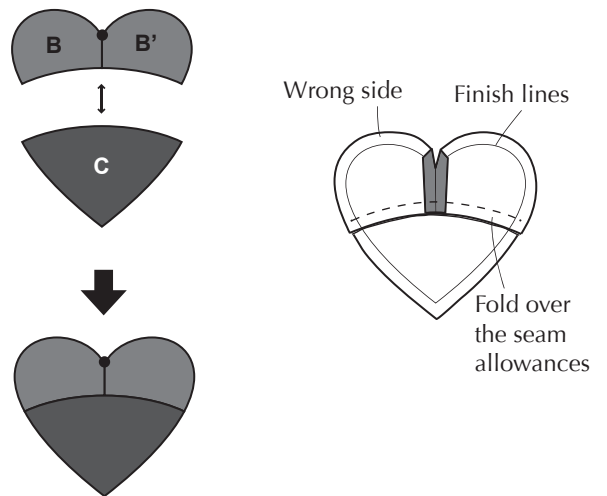

3 Place the sewing pattern on the wrong side of the hearts, pull tight a running stitch along the outsides, and iron into shape.

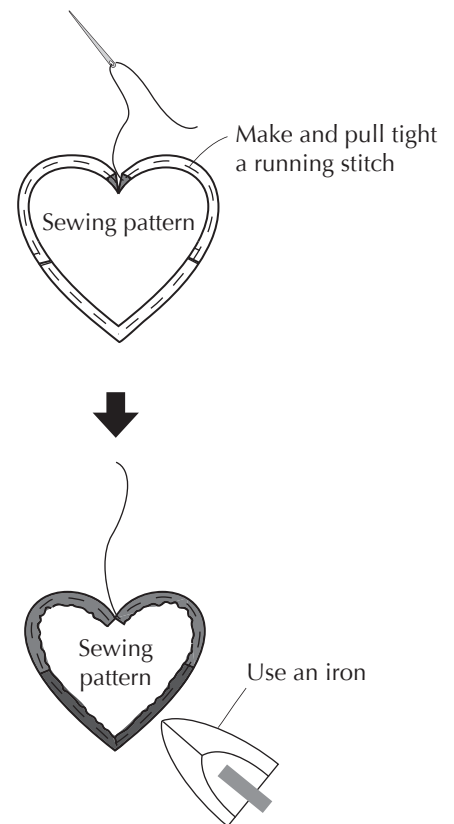

4 Make a mark on base material A, and appliqué. In the same way, make hearts [D, D' and E], [F, F' and G] and [H, H' and I] and appliqué.

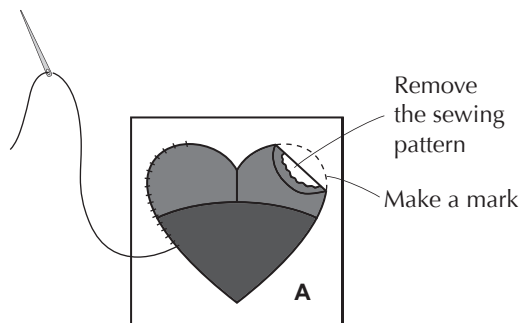

• Sew together the sides of the blocks

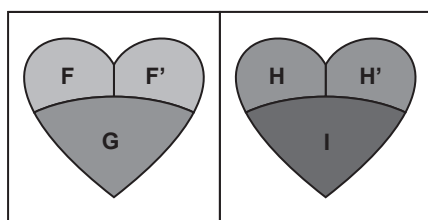
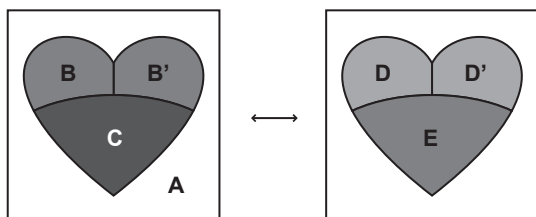

• Sew together the upper and lower blocks

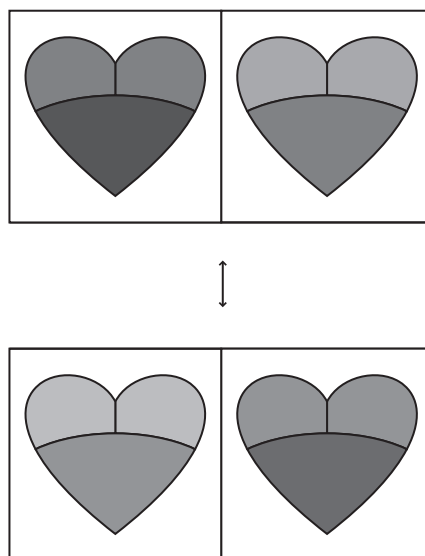

The task is completed.

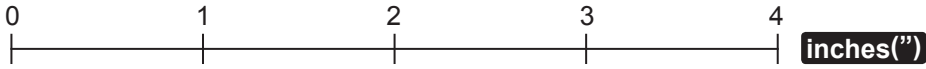
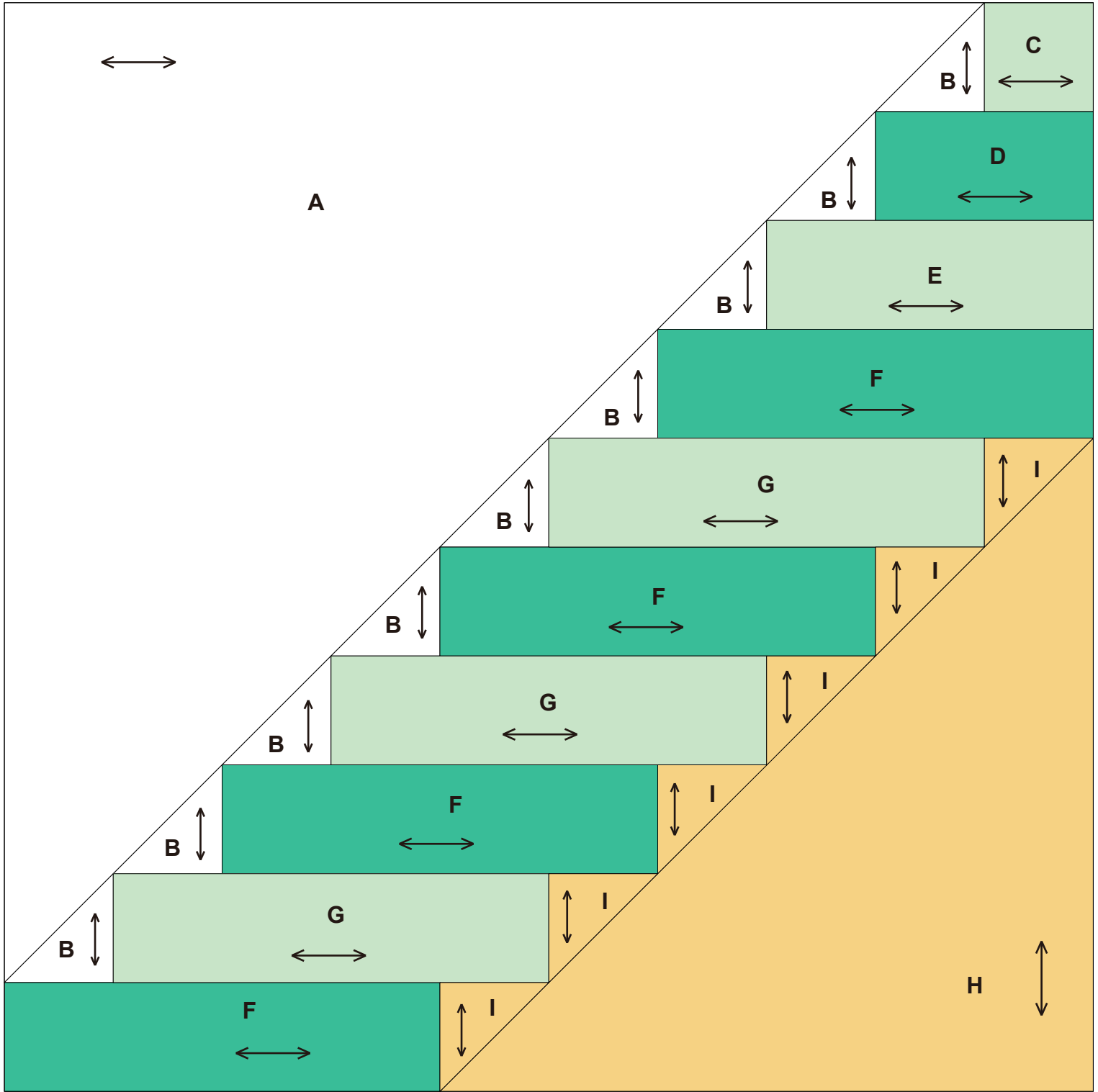

14 Stairs

Illustration of finished item

←...Fabric grain
200 mm × 200 mm (8"×8")

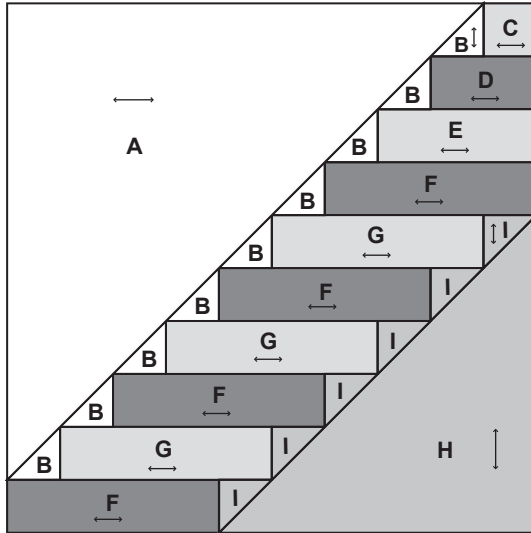

How to make

• Make the stair blocks

1 Sew together **B**, **C**, **D**, **E** and **F**, as shown in the figure.

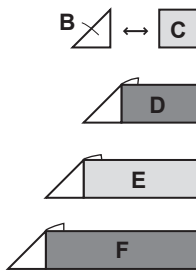

2 Sew **B** and **I** onto **G** and **F**.

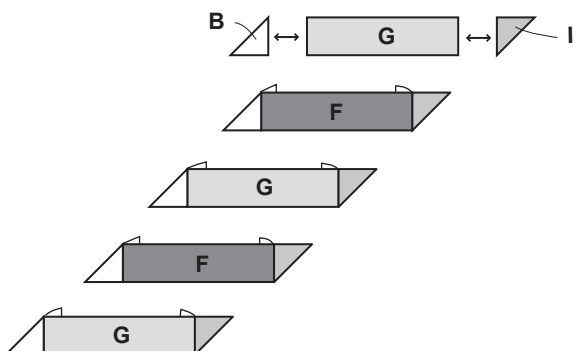

3 Sew together **F** and **I**.



4 Sew together the rows, as shown in the figure.

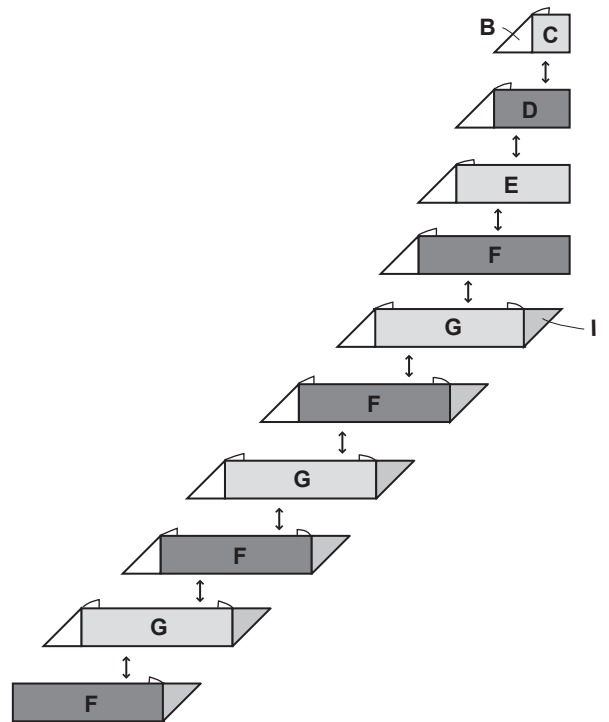

• Sew together the stair blocks to A and H

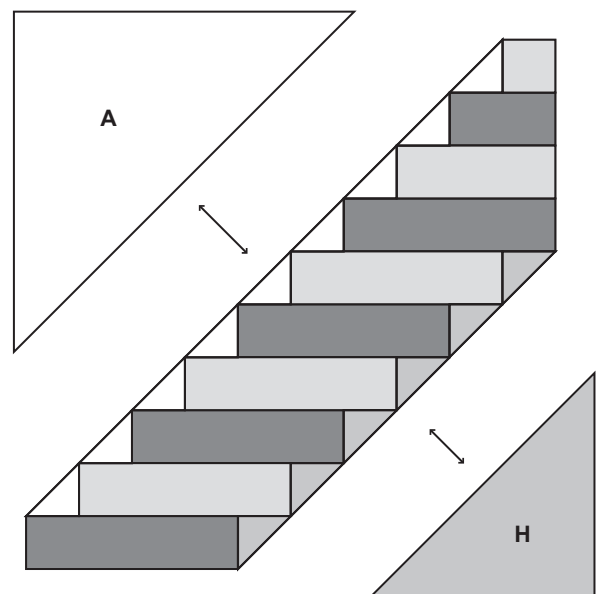

The task is completed.

15

Rickrack

Illustration of finished item

←...Fabric grain
200 mm × 200 mm (8"×8")

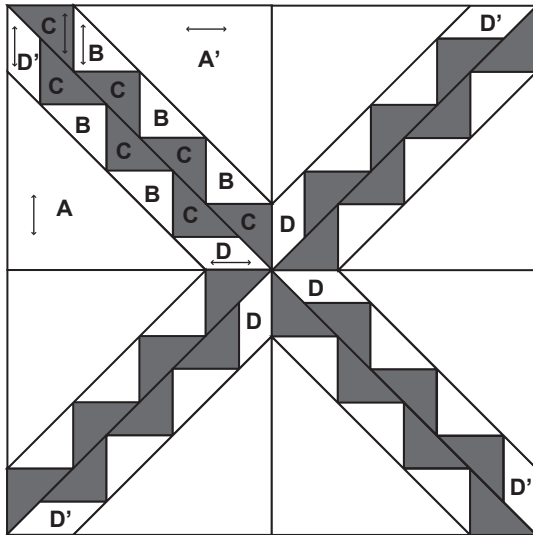

How to make

• Make rickrack blocks (four pieces)

1 Sew on **B**, **C**, **D** and **D'**, as shown in the figure.

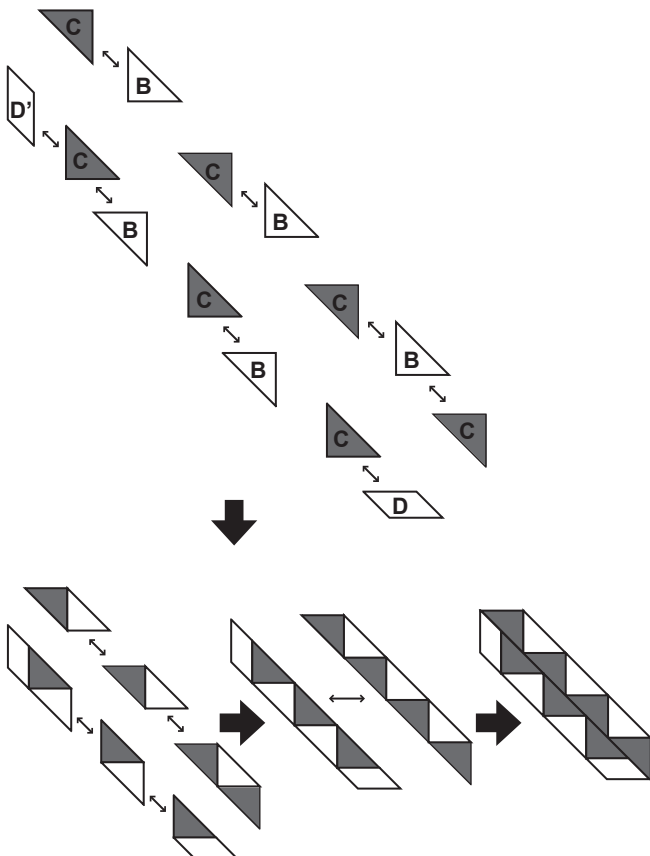

2 Sew the rickrack blocks onto **A**.

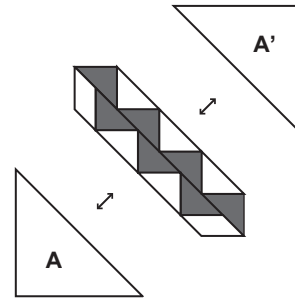

• Sew together the sides of the blocks

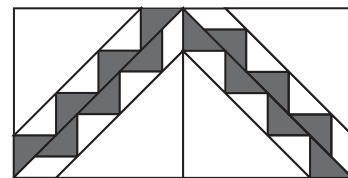
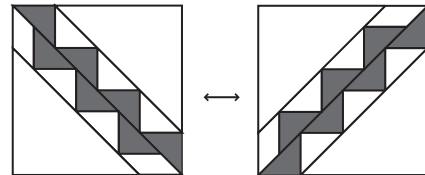

• Sew together the upper and lower blocks

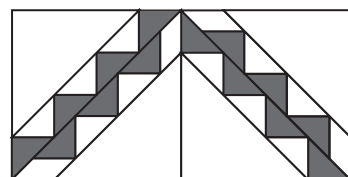
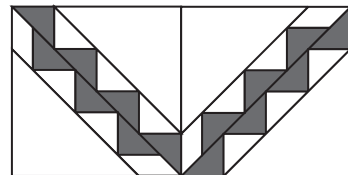

The task is completed.

16

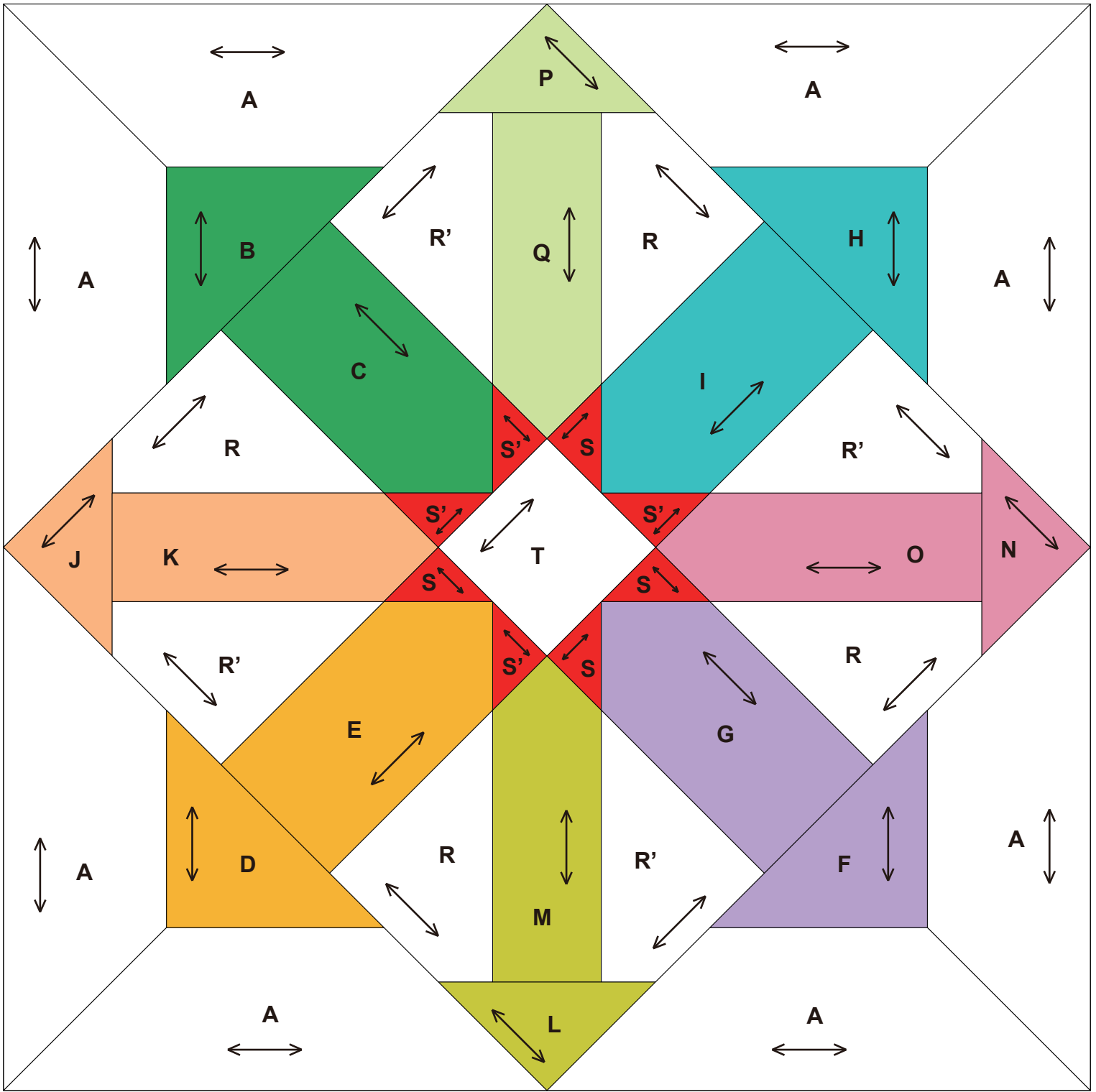

0 1 2 3 4 inches(")

0 50 100 mm

16 Flyaway

Illustration of finished item

←...Fabric grain
 ●...Mark ends
 200 mm × 200 mm (8"×8")

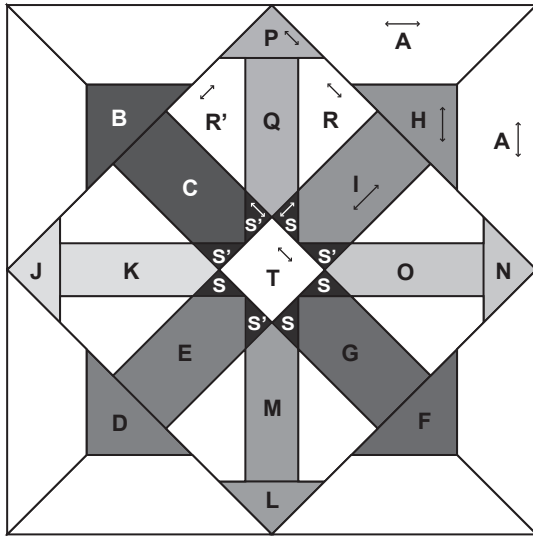

How to make

• Make the center block

1 Stitch together **Q, R** and **R'**, and then sew on **P**. In the same way, sew together **N** and **O**, **L** and **M**, and **J** and **K**. (Four pieces)

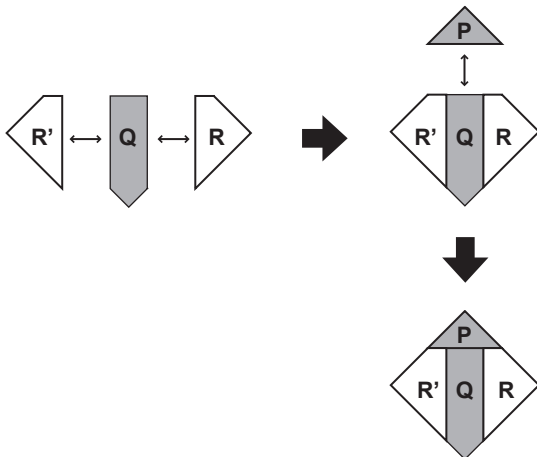

2 Sew together **I, S** and **S'**. In the same way, sew together blocks **G, S** and **S'**, **E, S** and **S'**, and **C, S** and **S'**. (Four pieces)

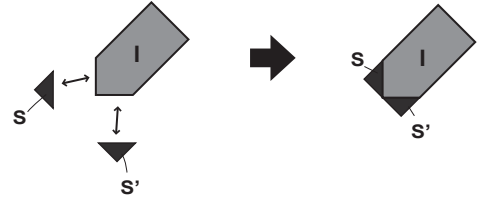

3 Sew together the blocks in a row, as shown in the figure.

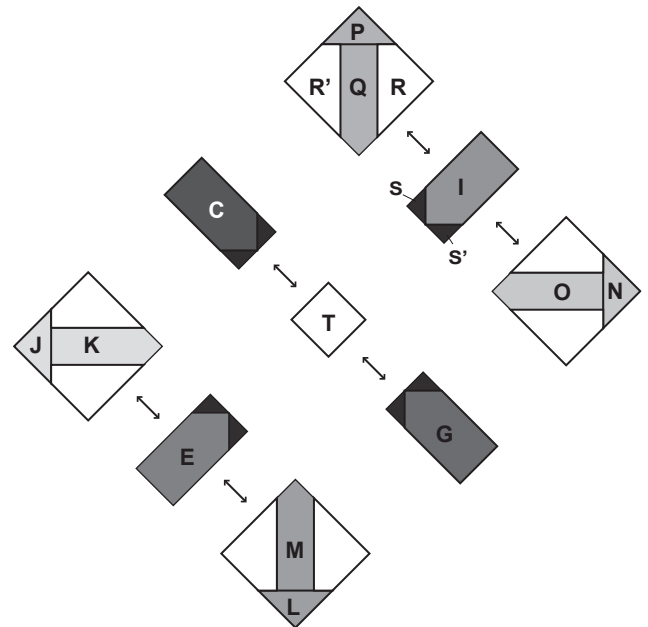

4 Sew the individual rows together.

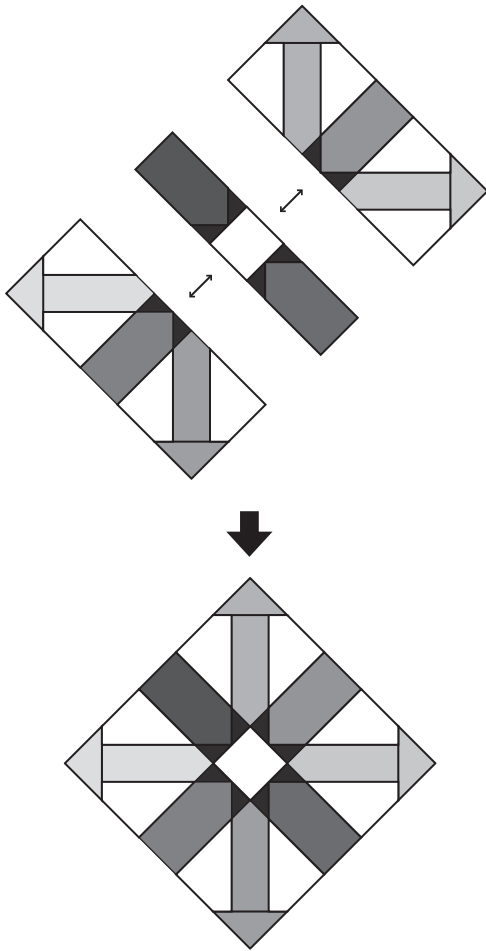

• Make angle blocks (four pieces)

1 Sew on A, taking care of the mark ends. (Four pieces)

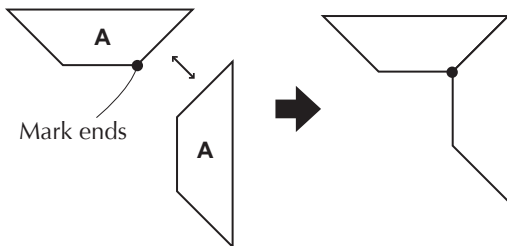

2 Sew the set-in seam on H, taking care of the mark ends.

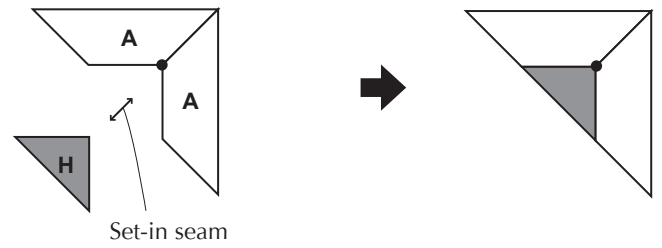

3 As with A, A and H, make blocks [A, A and B], [A, A and D] and [A, A and F].

• Sew together the blocks

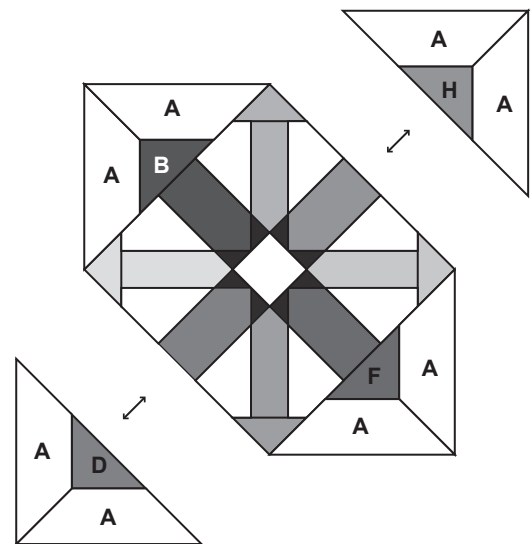

The task is completed.

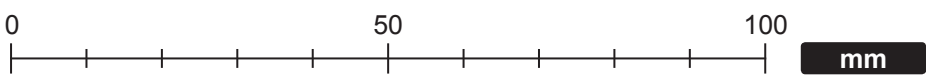
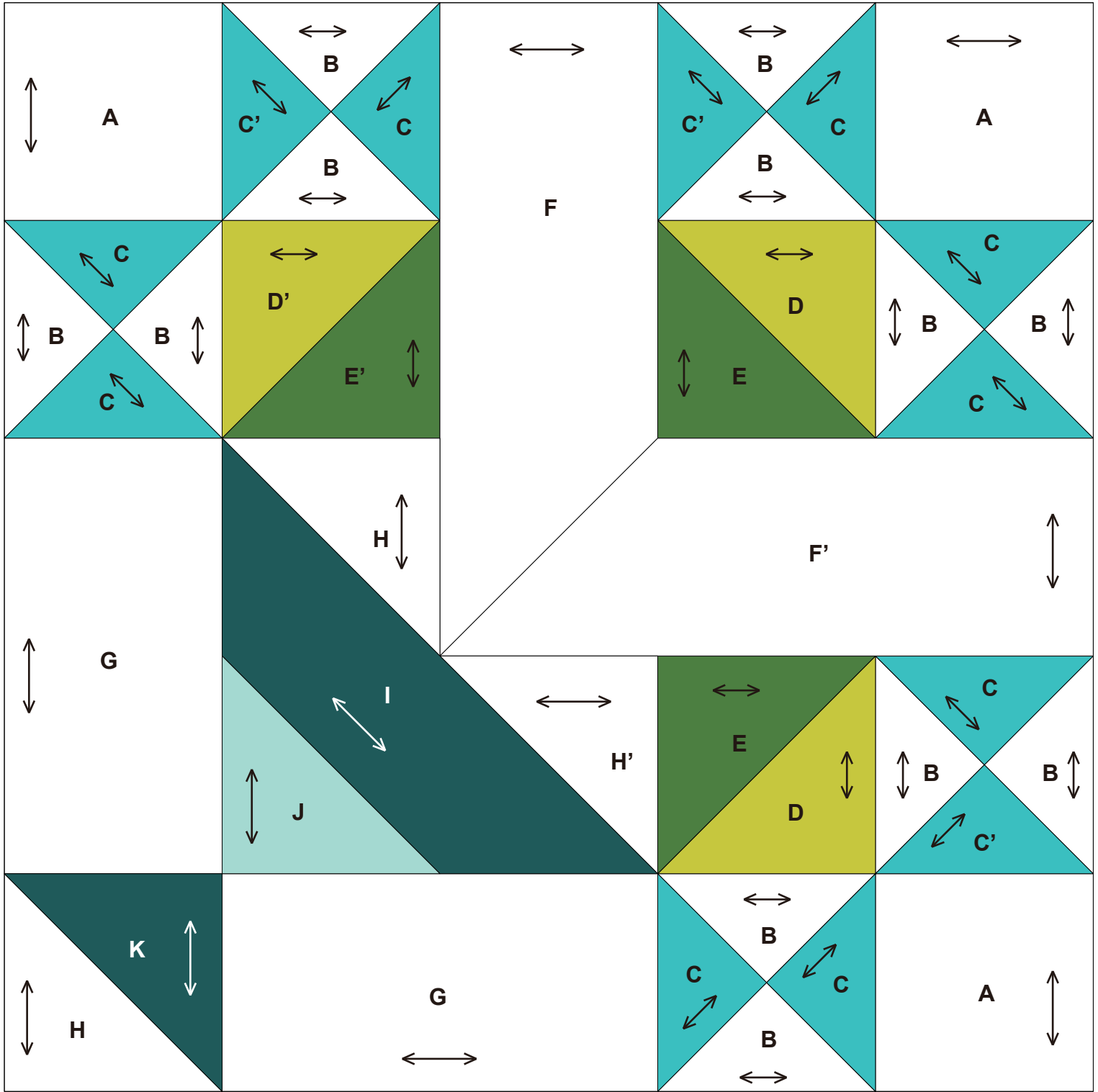
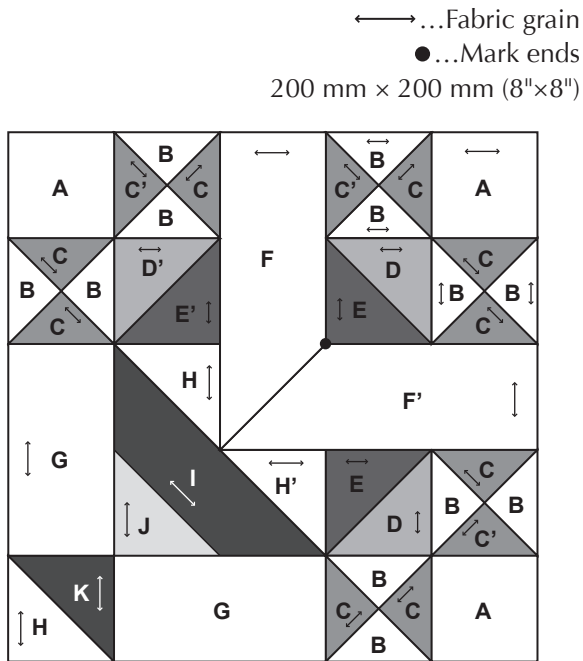

Illustration of finished item



How to make

• Make the center flower blocks

1 Sew together **B**, **C** and **C'**, as shown in the figure.
In the same way, sew together **B** and **C**.

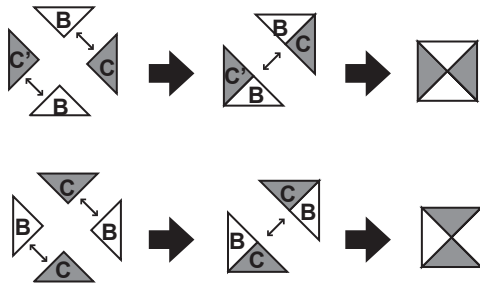

2 Sew together **D** and **E**.

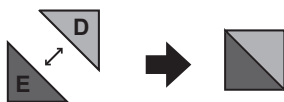

3 Sew on **A**, as shown in the figure.

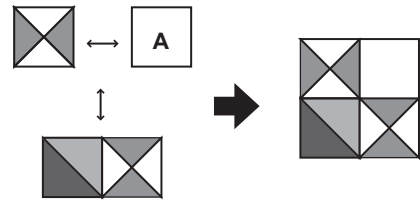

4 Taking care of the mark ends, sew together **F** and **F'** and make set-in seams on the blocks you have made.

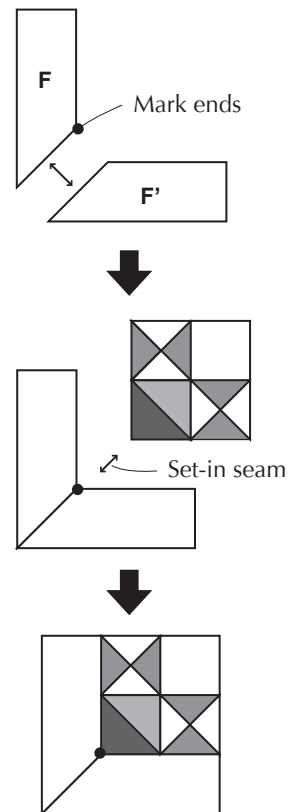

• Make the left and right flower blocks

1 Referring to the figure, sew together the center flower blocks.

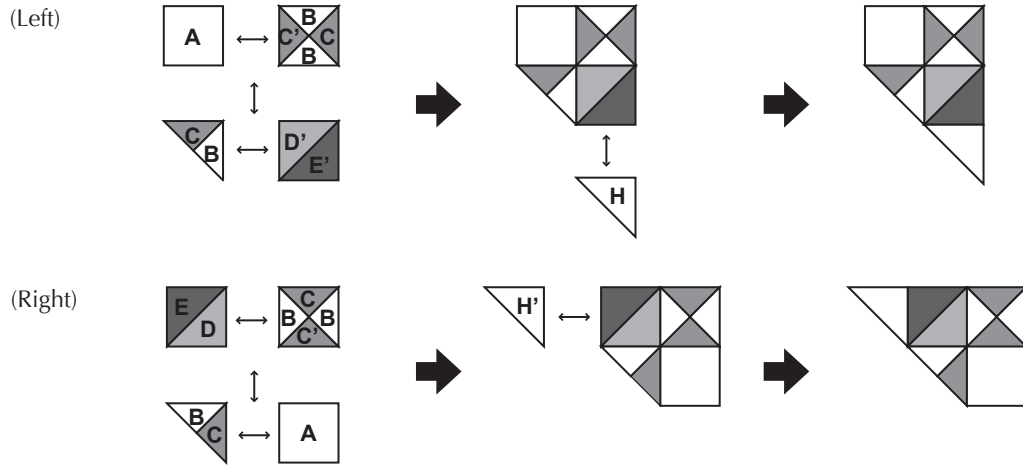

• Make the pot block

1 Sew together, as shown in the figure.

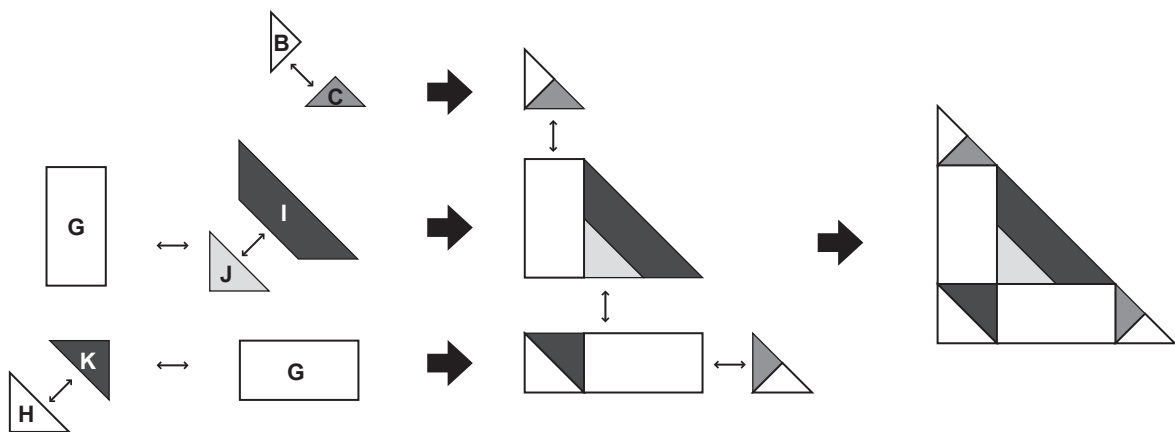

• Sew together the flower blocks

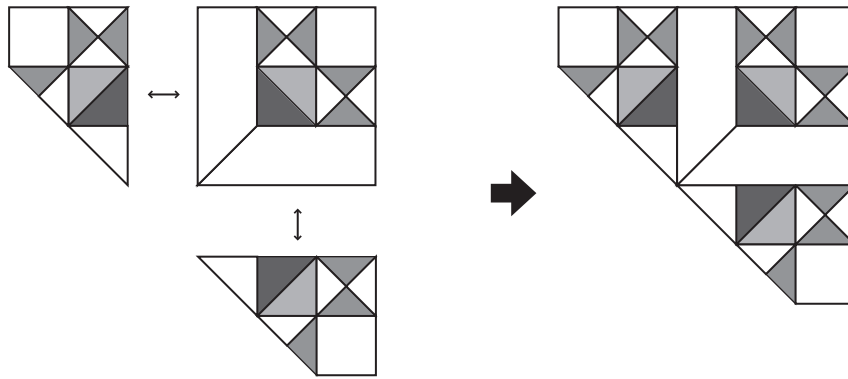

• Sew together the upper and lower blocks

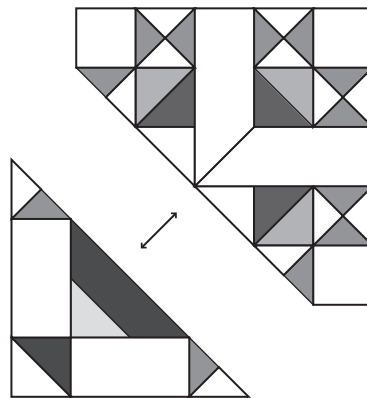

The task is completed.

18

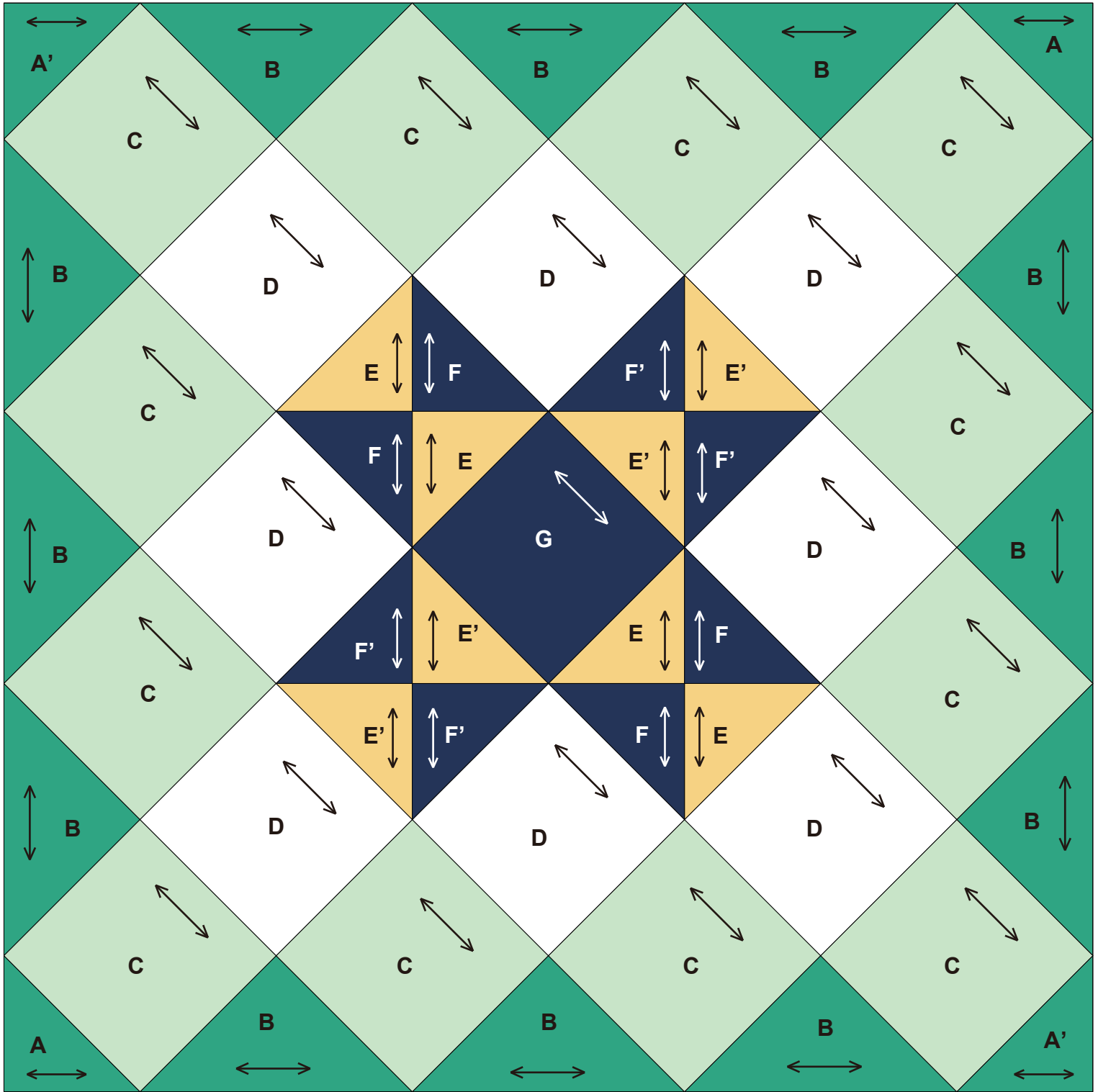
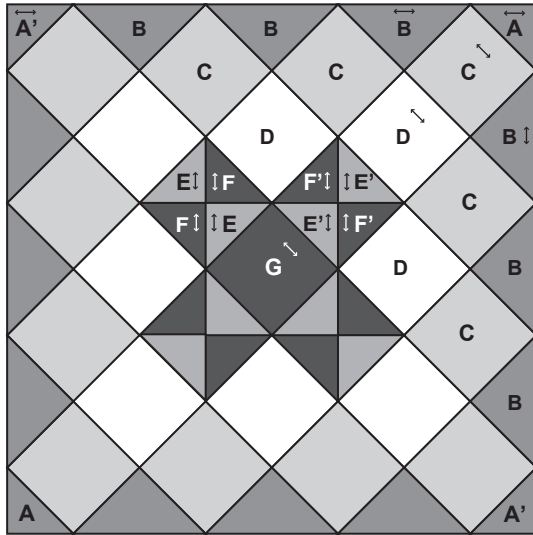

Illustration of finished item

←...Fabric grain
200 mm × 200 mm (8"×8")



How to make

• Sew together the pieces into angled rows

1 Stitch together **B** and **C** as shown in the figure, and then sew on **A**. (Two pieces)

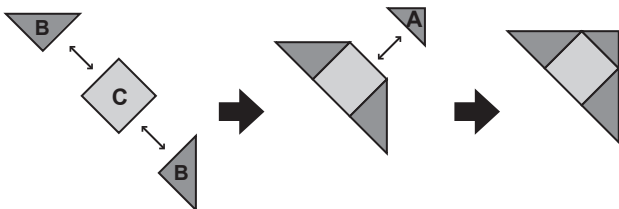

2 Sew together **B**, **C** and **D**, as shown in the figure. (Two pieces)

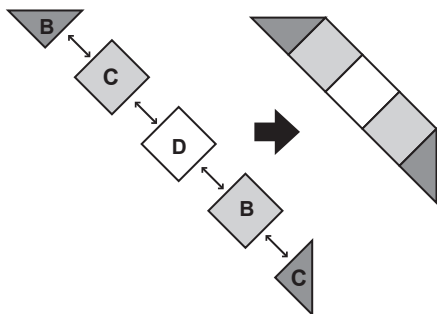

3 Stitch together **E'** and **F'** as shown in the figure, and then sew together **B**, **C** and **D**. (Two pieces)

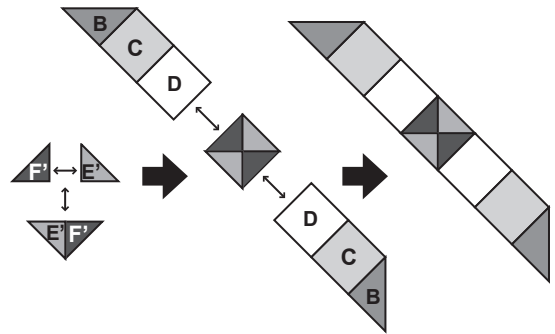

4 Sew together the center row, as shown in the figure.

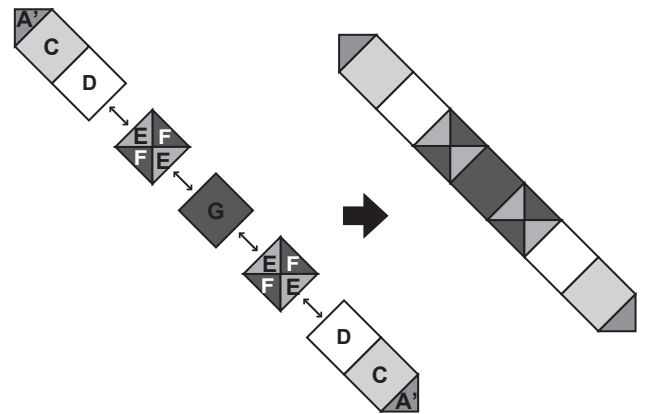

- Sew the individual rows together

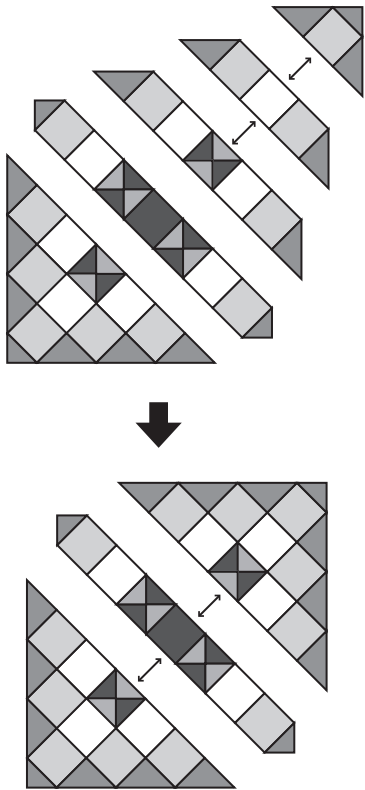

The task is completed.

19 Lattice

Illustration of finished item

←→...Fabric grain
200 mm × 200 mm (8"×8")

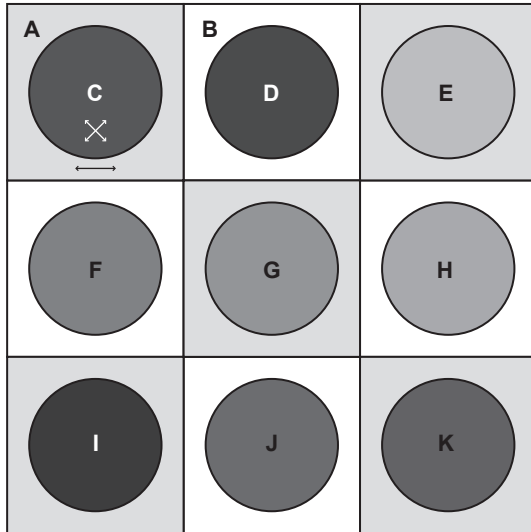

How to make

• Make the circle appliqués (nine pieces)

- 1 Place the sewing pattern on **C, D, E, F, G, H, I, J** and **K**, pull tight a running stitch along the outsides, and iron into shape.

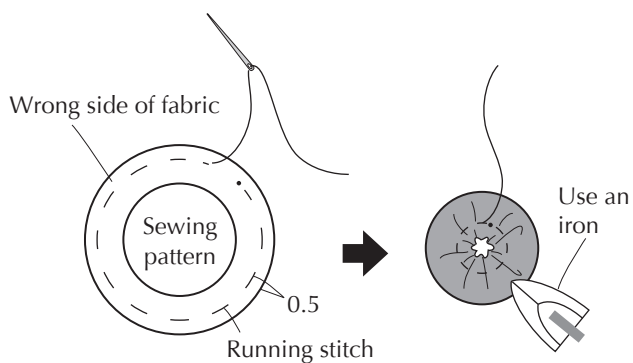

- 2 Make a mark on base materials **A** and **B**, and appliqué them.

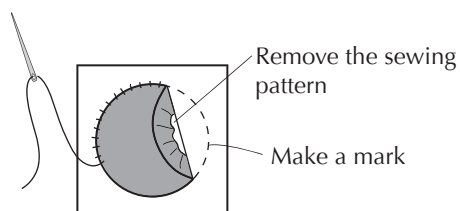

• Sew together the sides of the blocks

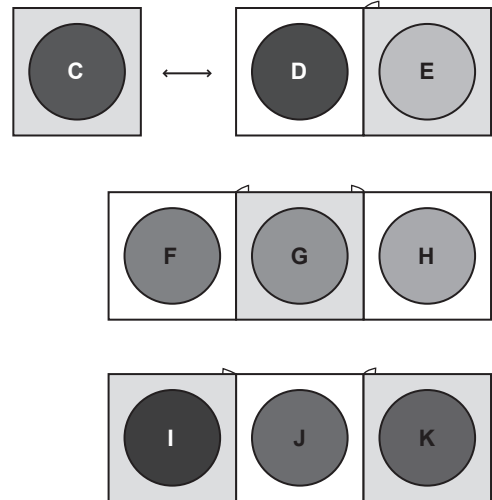

• Sew the individual rows together

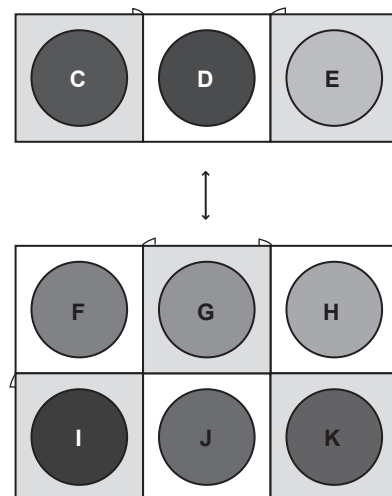

The task is completed.

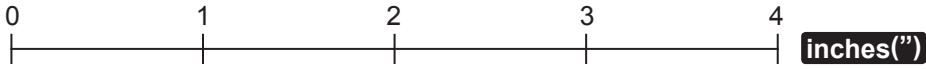
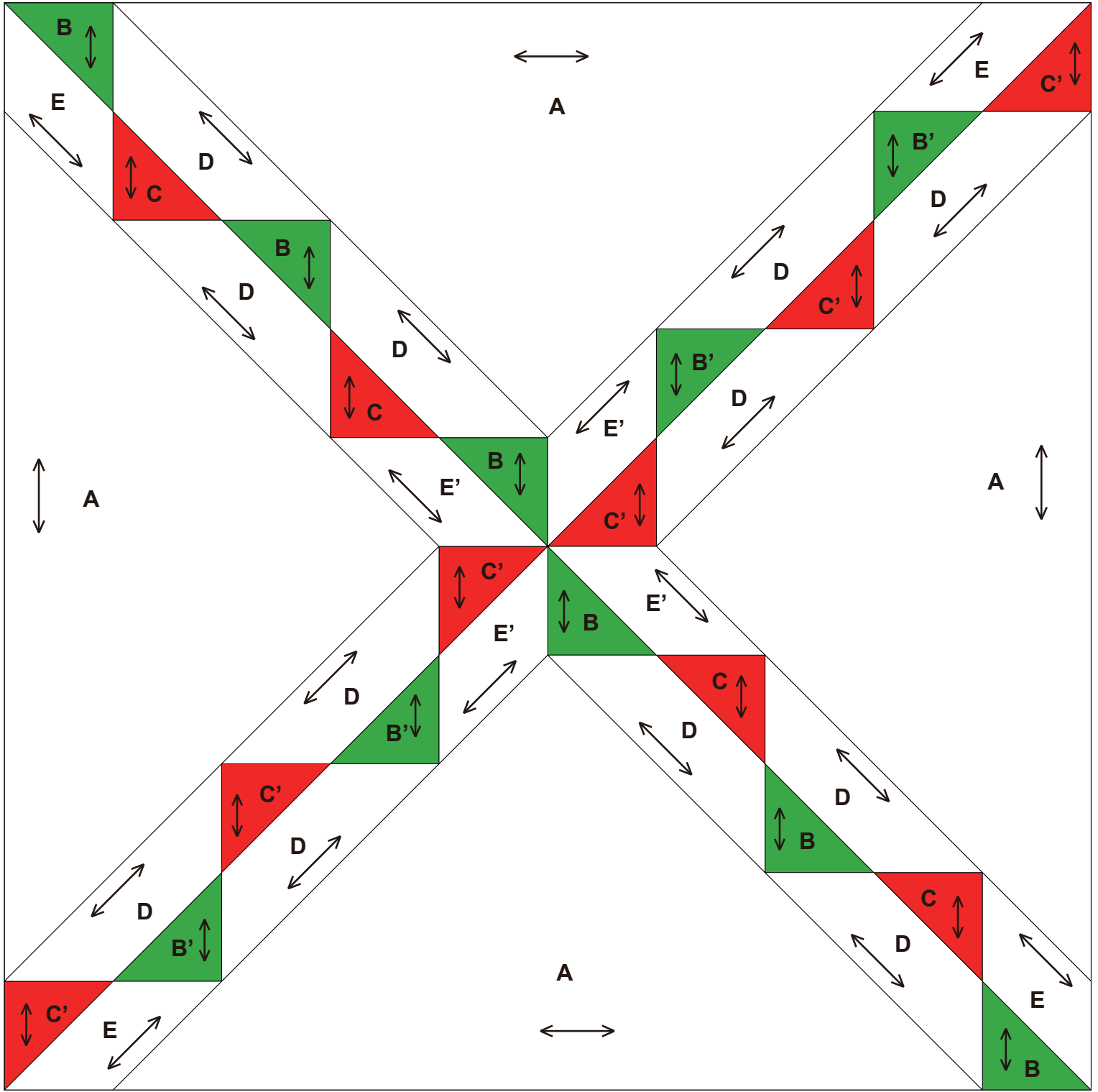

- 5 Sew the set-in seam on the remaining **A**, taking care of the mark ends.

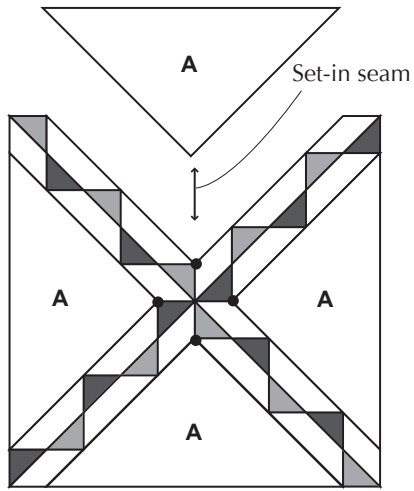

The task is completed.

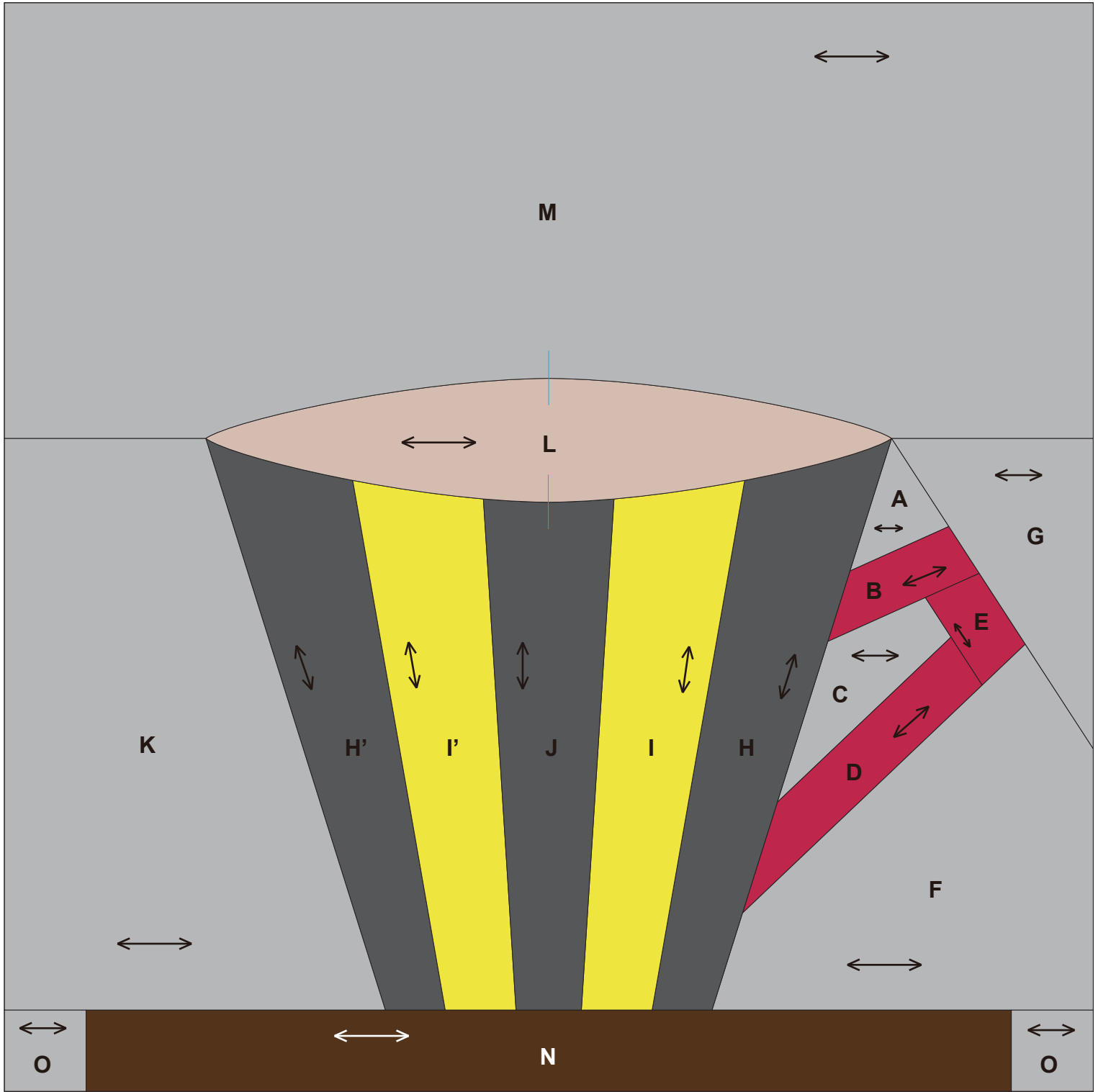

0 1 2 3 4 inches(")

0 50 100 mm

Illustration of finished item

←...Fabric grain
 ●...Mark ends
 200 mm × 200 mm (8"×8")

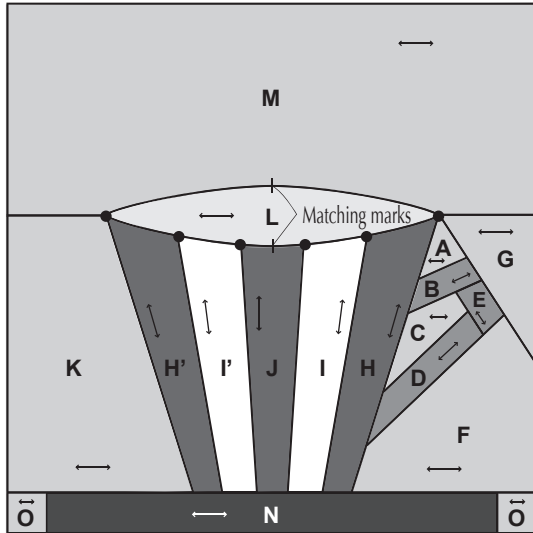

How to make

• Make the mug block

1 Stitch **H, I, J, I'** and **H'** together, taking care of the mark ends.

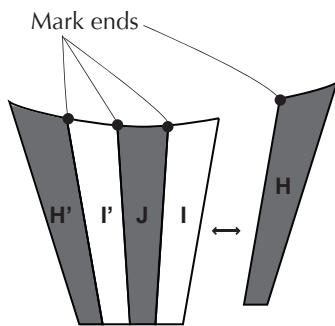

2 Make the handle.
 Stitch together **C** and **D**, and then sew on **E**.

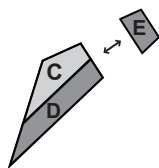

3 Stitch together **A** and **B**, and then sew together **C, D** and **E**.

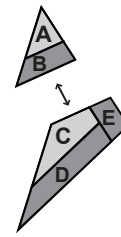

4 Sew on **F**.

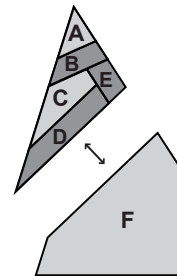

5 Sew on **G**, taking care of the mark ends.

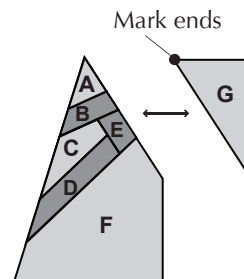

6 Sew on the handle block, taking care of the mark ends.

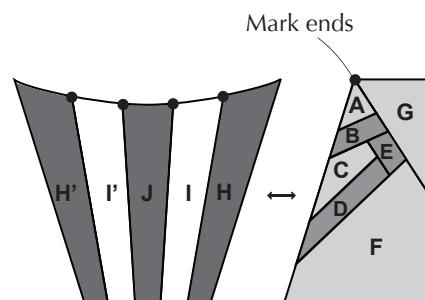

7 Sew on **K**, taking care of the mark ends.

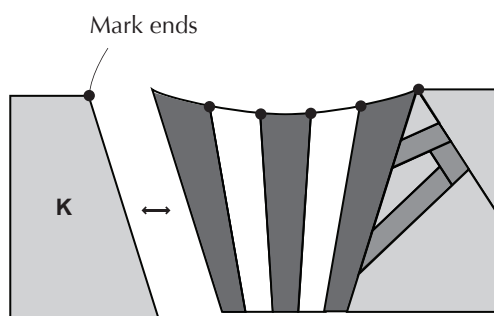

8 Make a set-in seam on **L**.
(Line up the matching marks.)

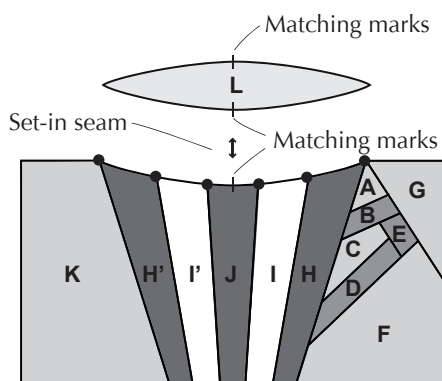

9 Sew the set-in seam on **M**, taking care of the mark ends. (Line up the matching marks.)

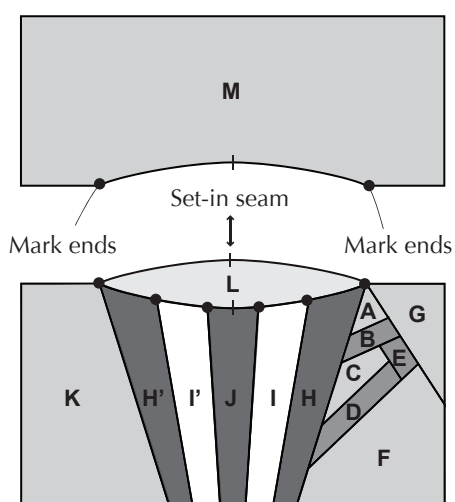

• **Make the saucer block**

1 Sew together **N** and **O**.



• **Sew together the upper and lower blocks**

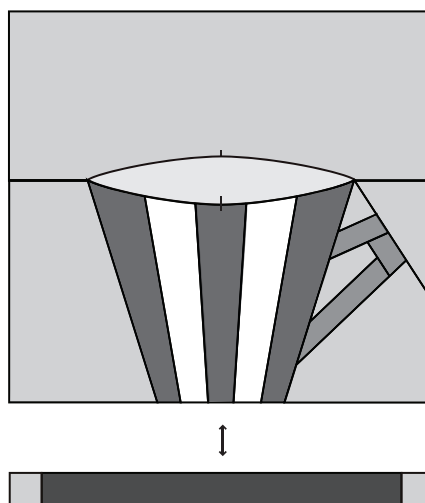

The task is completed.

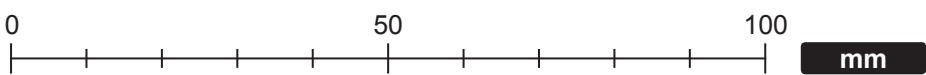
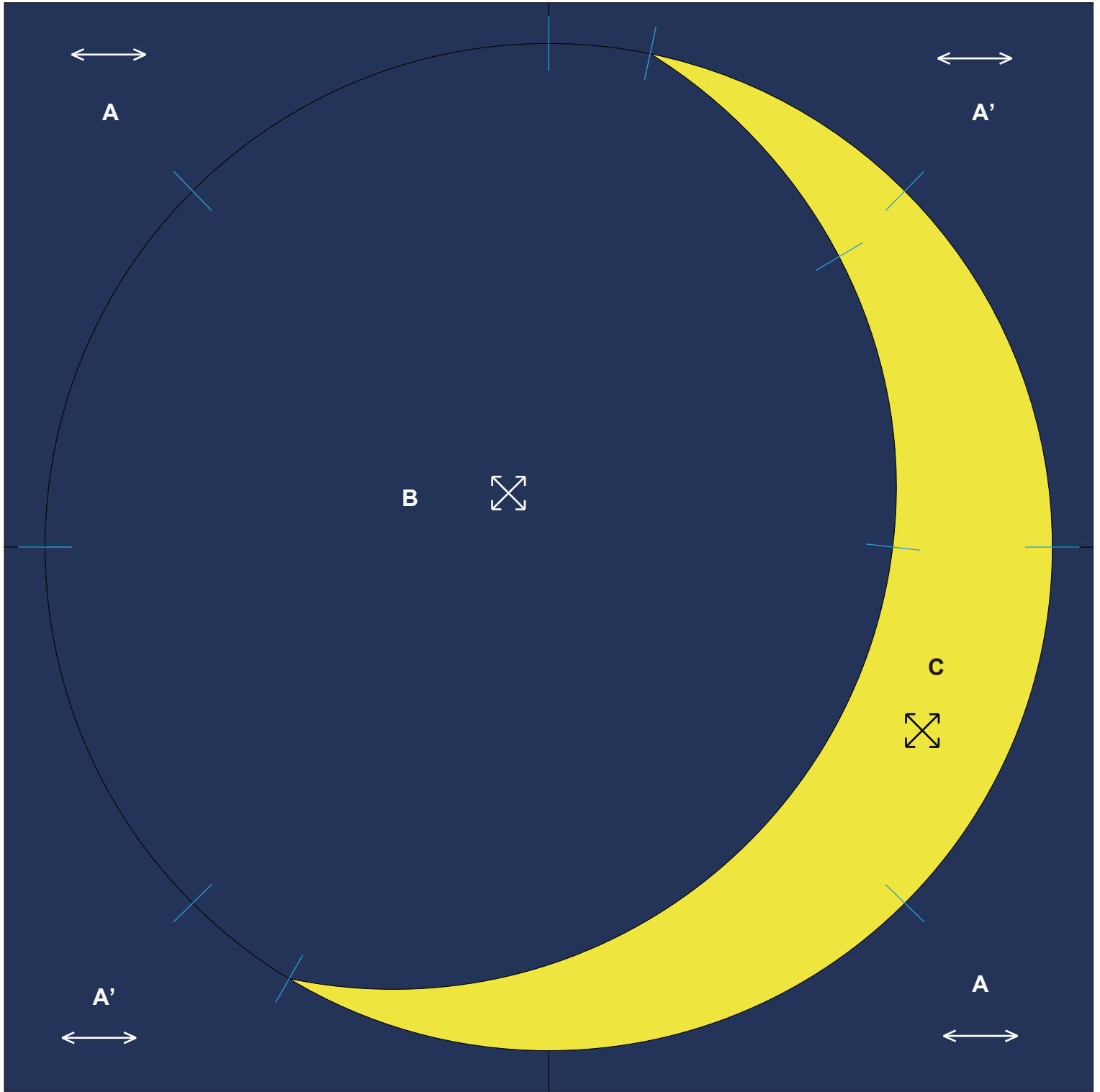

22 Moon

Illustration of finished item

←...Fabric grain
200 mm × 200 mm (8"×8")

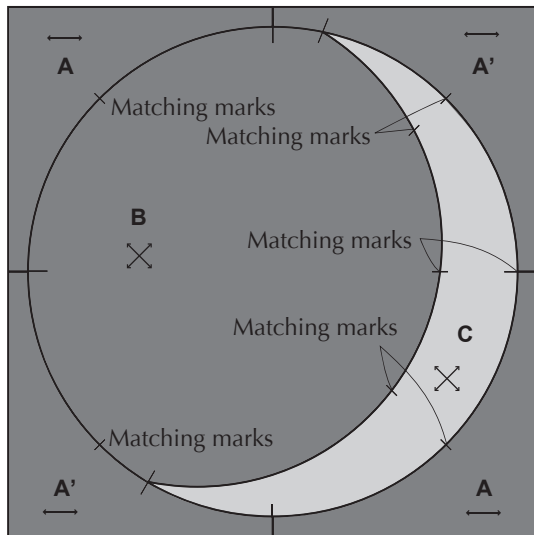

How to make

• Make the moon block

- 1 Stitch together **B** and **C**, lining up the matching marks.
(Use a pin to make fine holes to make it easier to sew. Also, sewing out to the end strengthens it.)

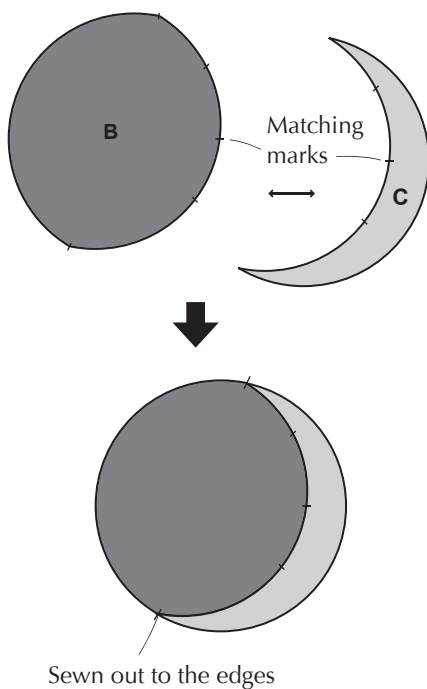

• Make the background fabric

- 1 Sew together **A** and **A'** as shown in the figure, and then sew together the top and bottom blocks.

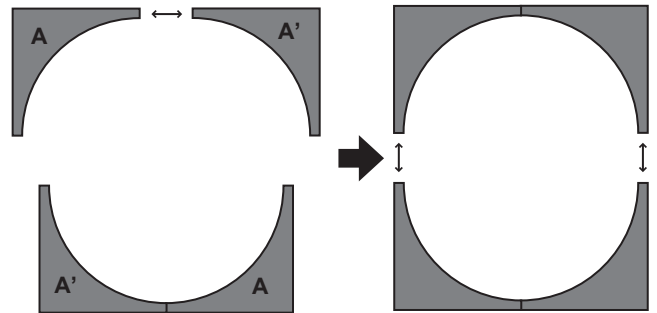

• Sew together the moon block and the background fabric

- 1 Align the matching marks, sew together, dividing the moon block into four sections.
(Use a pin to make fine holes to make it easier to sew.)

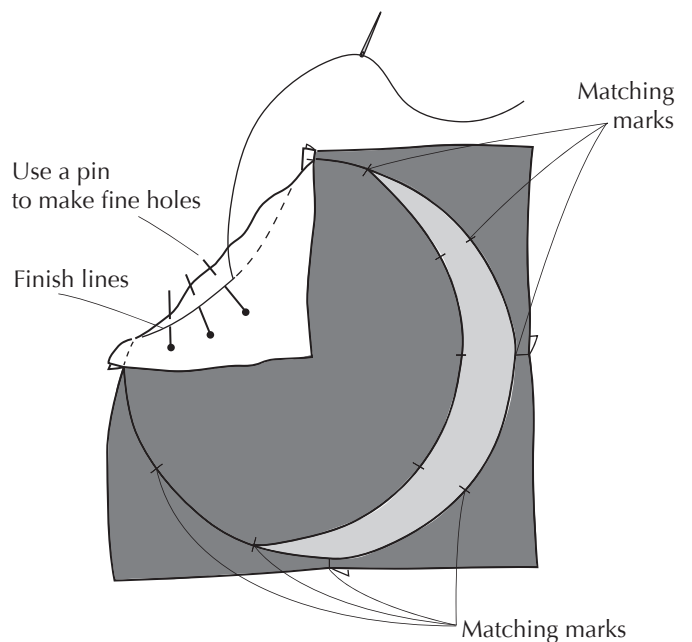

The task is completed.

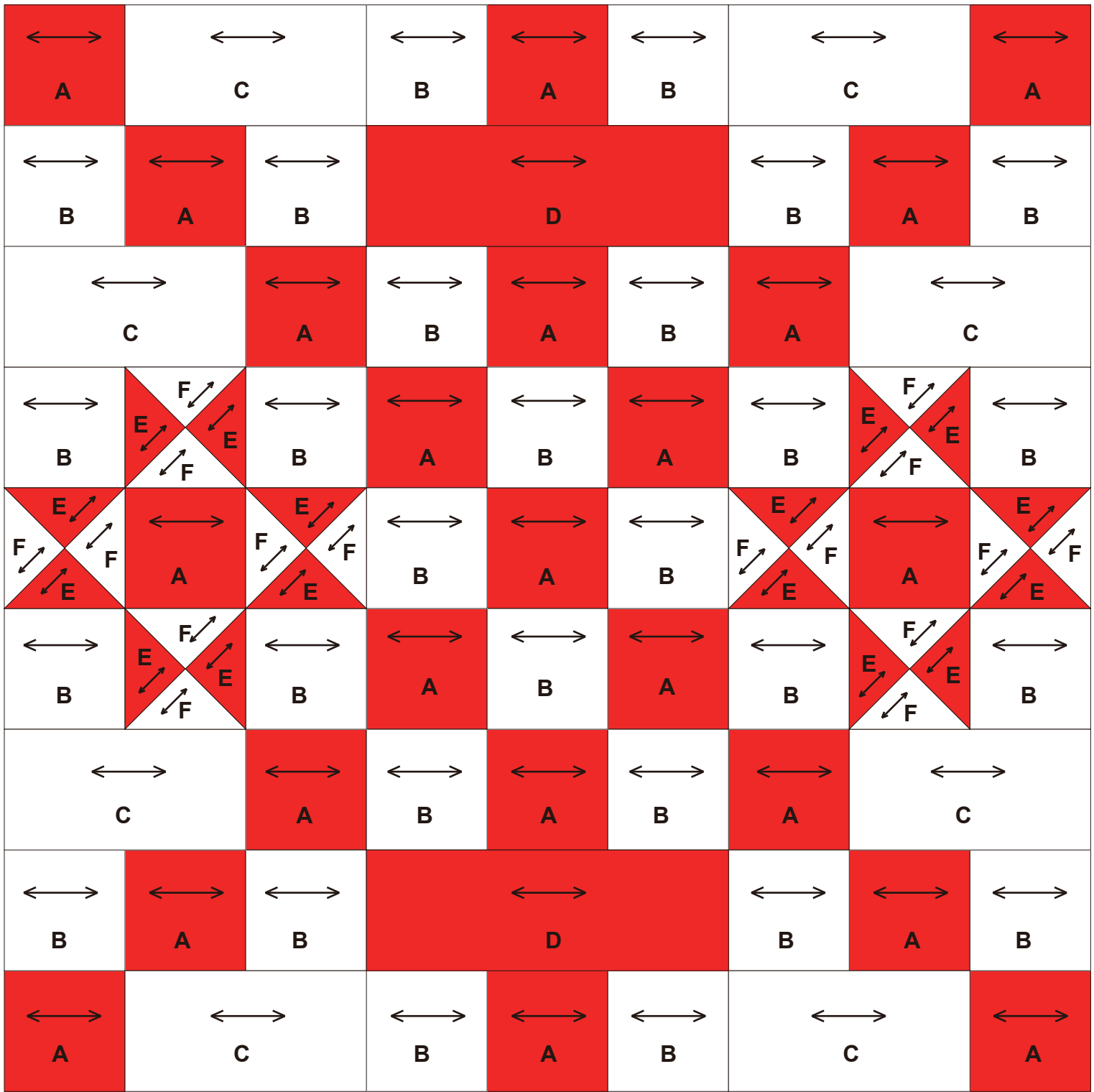
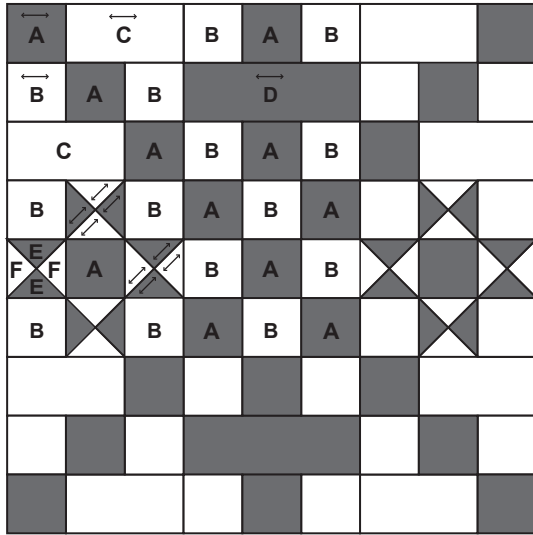

Illustration of finished item

←...Fabric grain
200 mm × 200 mm (8"×8")



How to make

• Make nine patterns

- 1 Make the cross patterns. (Two pieces)
Sew together **A**, **B** and **D**, as shown in the figure.

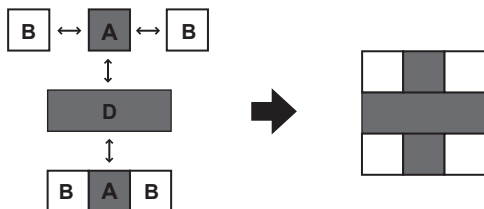

- 2 Make the star patterns. (Two pieces)
Stitch together **E** and **F**, and then sew together **A** and **B** as shown in the figure.

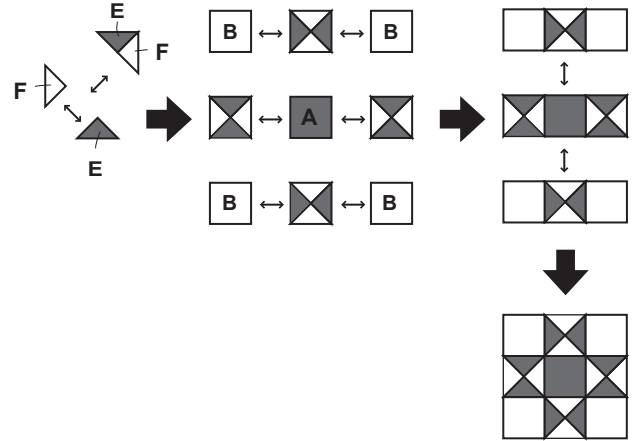

- 3 Make the nine-patch pattern. (One piece)
Sew together **A** and **B**, as shown in the figure.

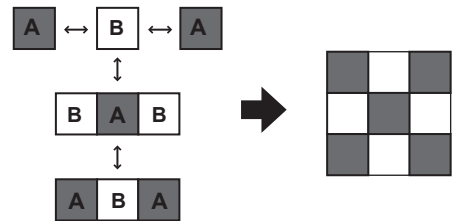

4 Make the four-cornered pattern. (Four pieces)
Sew together A, B and C, as shown in the figure.

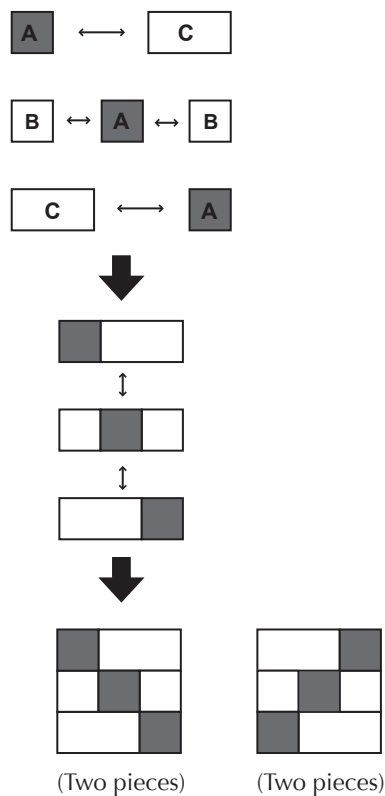

• Sew the individual rows together

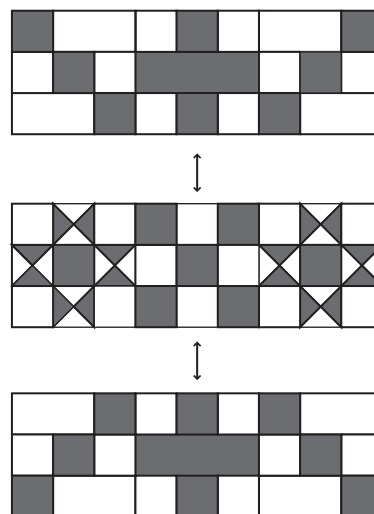

The task is completed.

• Sew together the sides of the patterns

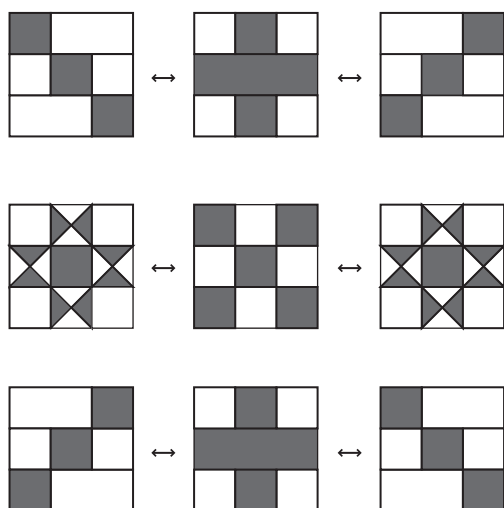

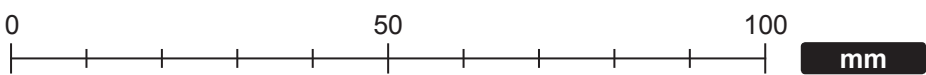
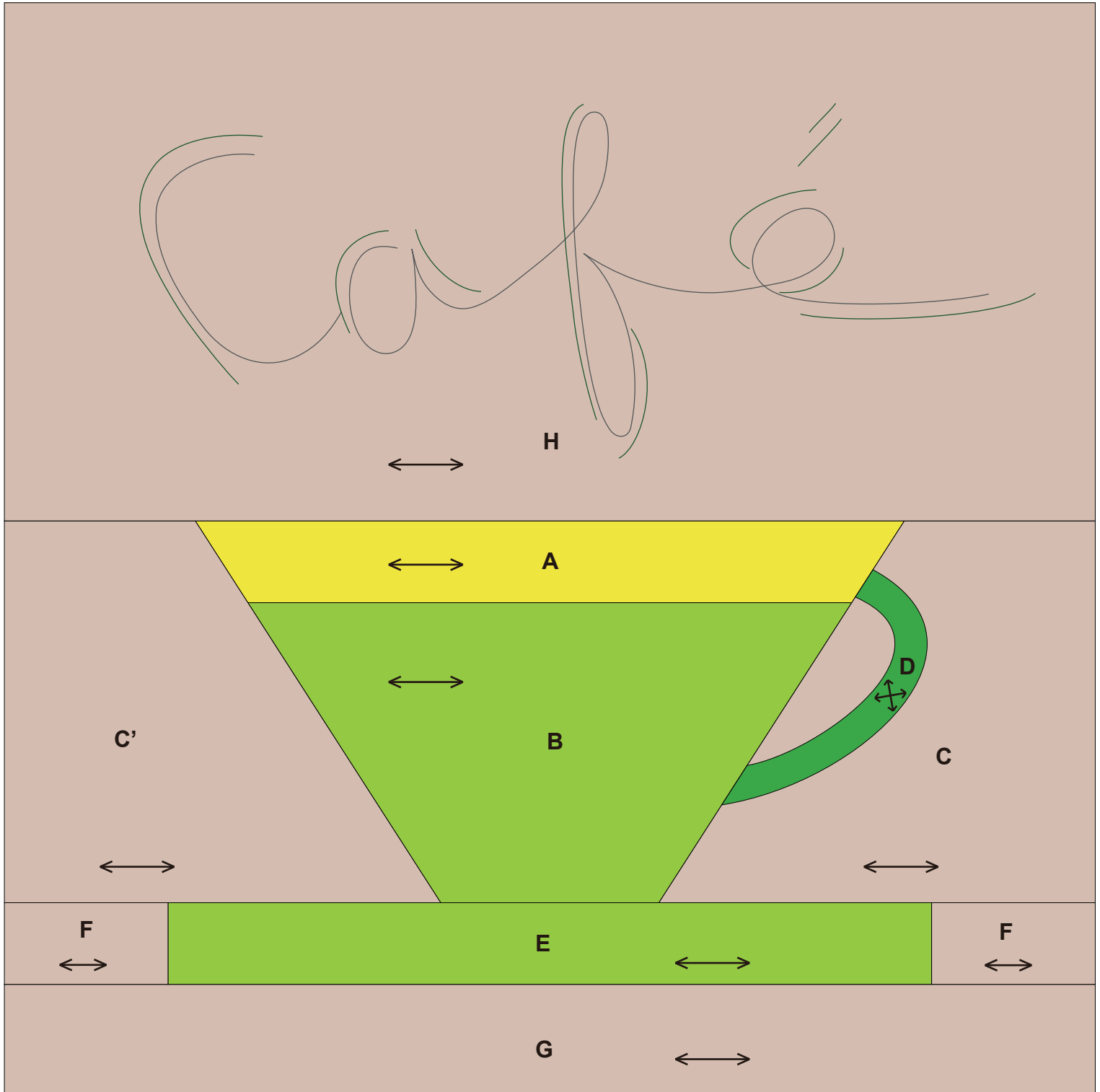
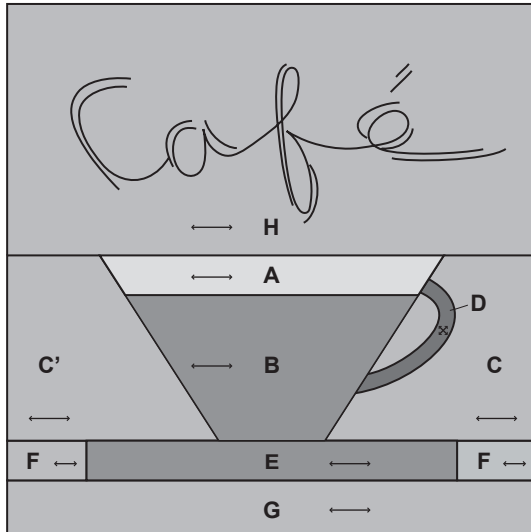

Illustration of finished item

←...Fabric grain
200 mm × 200 mm (8"×8")



How to make

• Make the cup blocks

1 Sew together A and B.

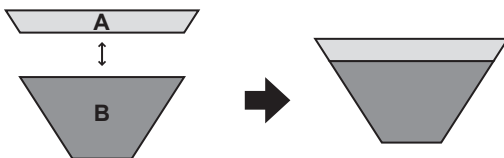

2 Appliqué the handle D to C.
Place sewing pattern D on the wrong side of the fabric, and iron it into shape.
(Make cuts in the seam allowance.)

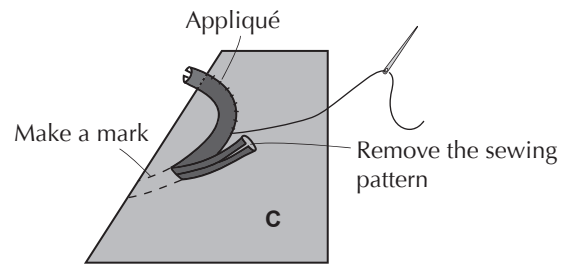
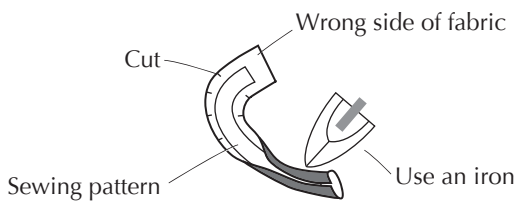

3 Sew together C and C'.

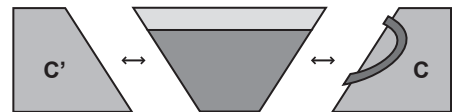

4 Sew together E and F.



5 Sew together, as shown in the figure.

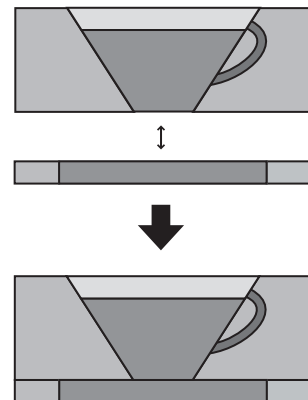

- Sew together the entire design, and embroider

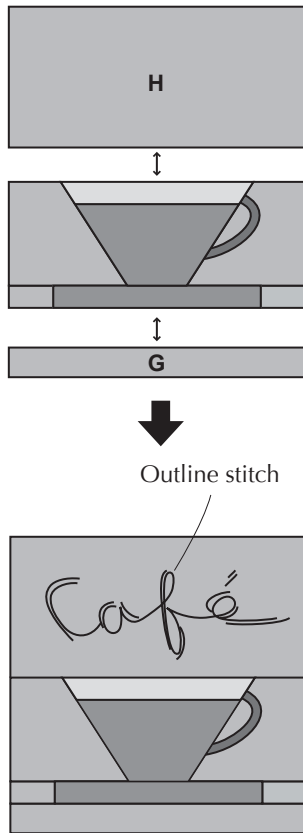

The task is completed.

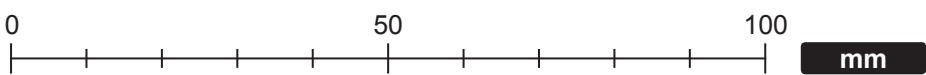
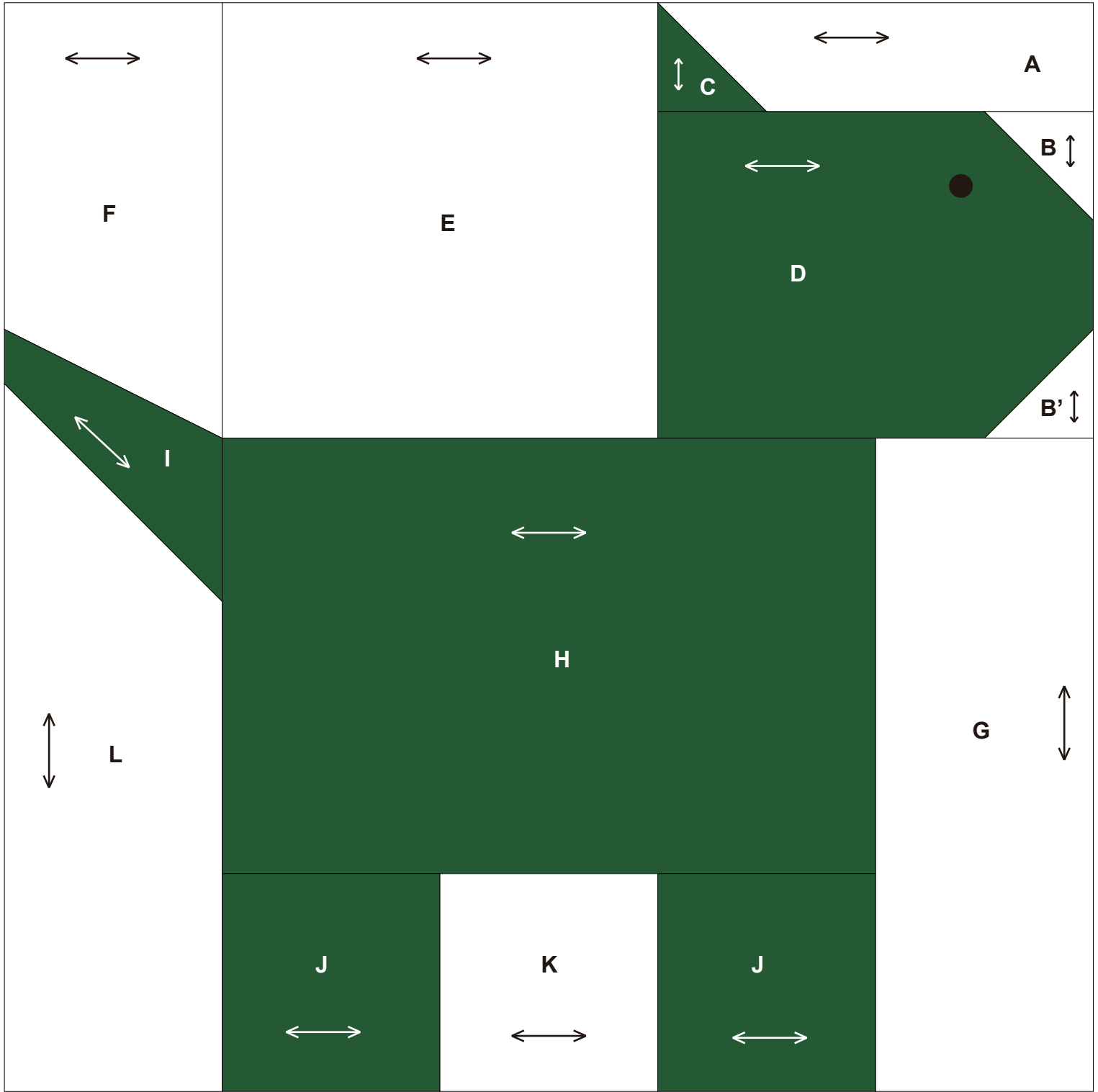
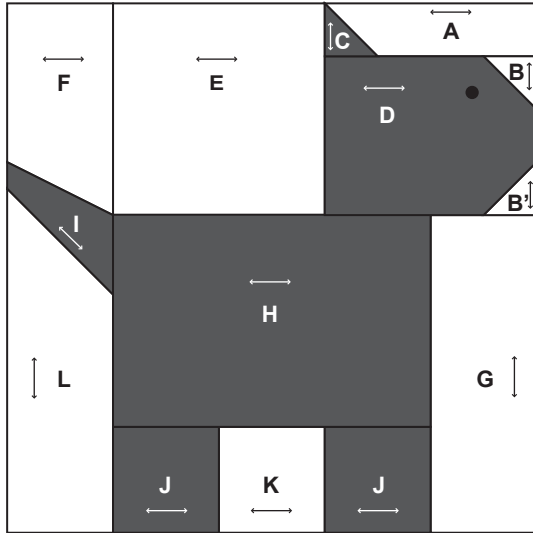

Illustration of finished item

←...Fabric grain
200 mm × 200 mm (8"×8")



How to make

• Make the head block

1 Sew together A and C.



2 Sew together B, B' and D.

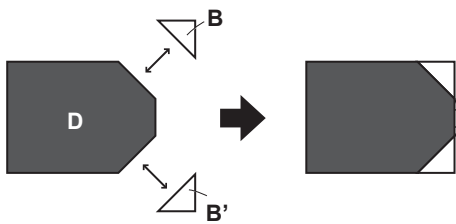

3 Sew together, as shown in the figure.

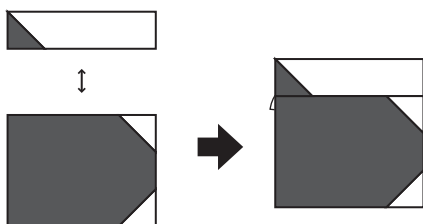

4 Sew on E.

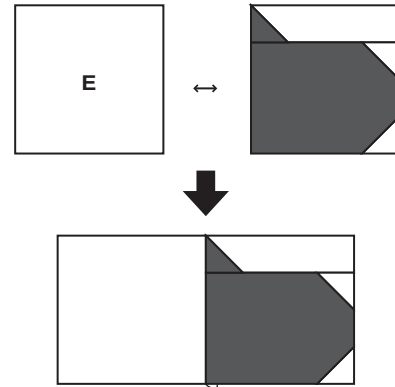

• Make the body block

1 Sew together K and J.

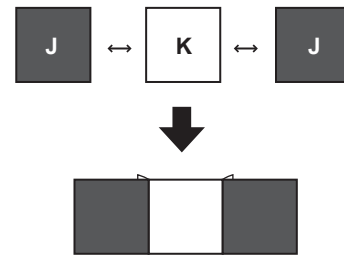

2 Sew on H.

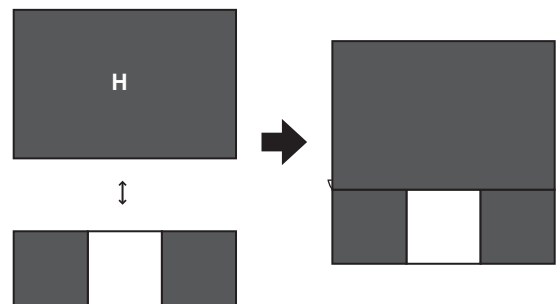

3 Sew on G.

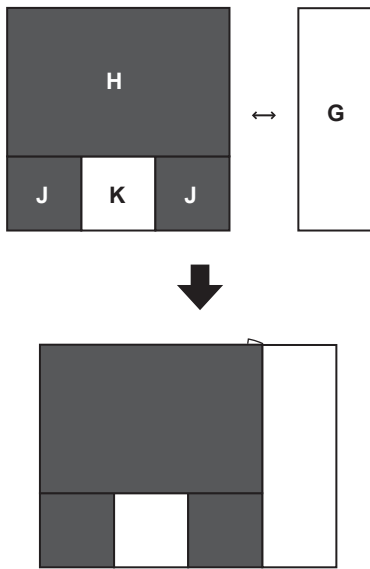

• **Make the tail block**

1 Sew together F, I and L.

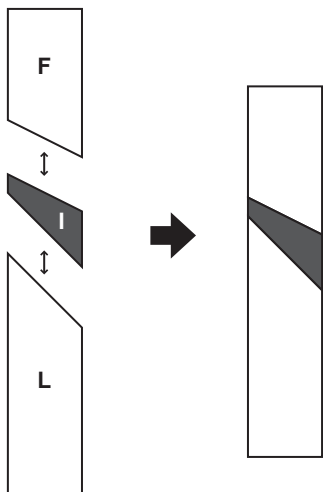

• **Sew together the entire design, and embroider on the eyes**

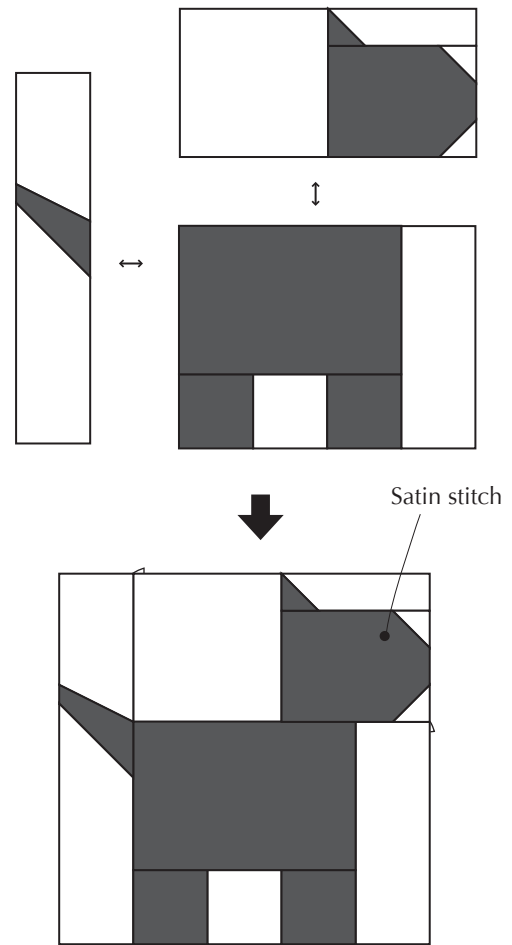

The task is completed.

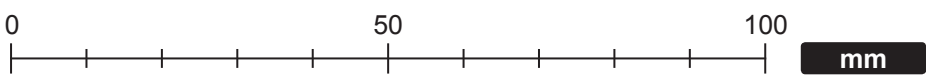
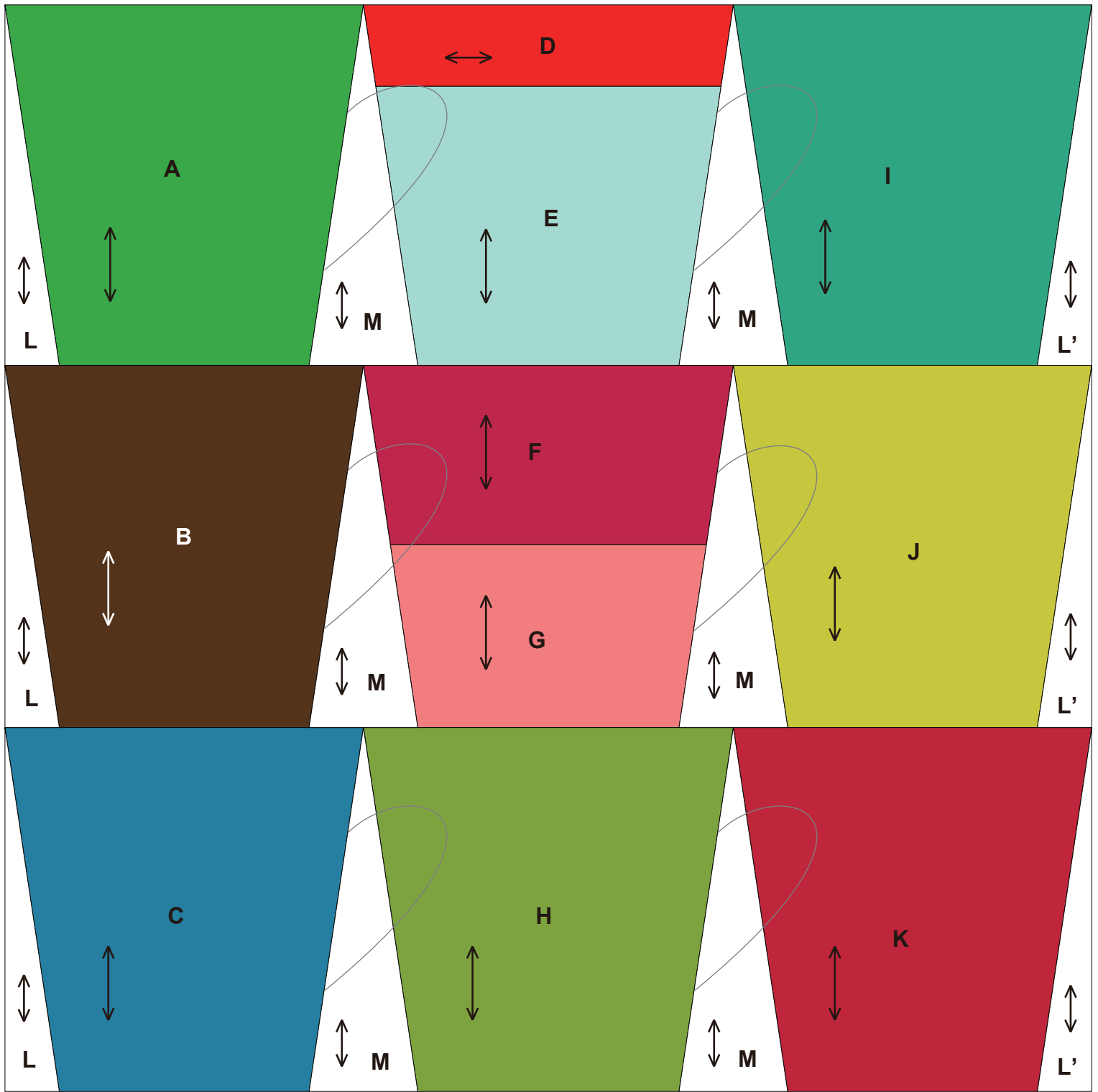
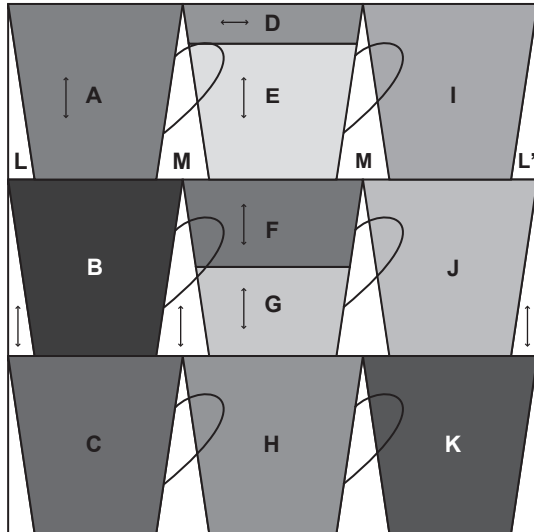

Illustration of finished item

←→ ...Fabric grain
200 mm × 200 mm (8" × 8")



How to make

• Make a nine-cup color pattern

1 Sew together **D** and **E**.

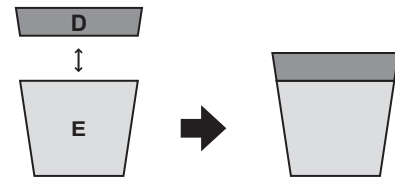

2 Sew together **F** and **G**.

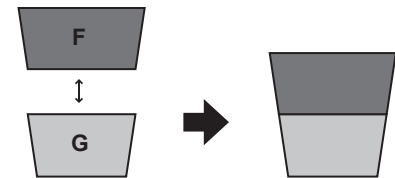

• Sew together the cups and sew together on the sides with **L**, **L'** and **M**

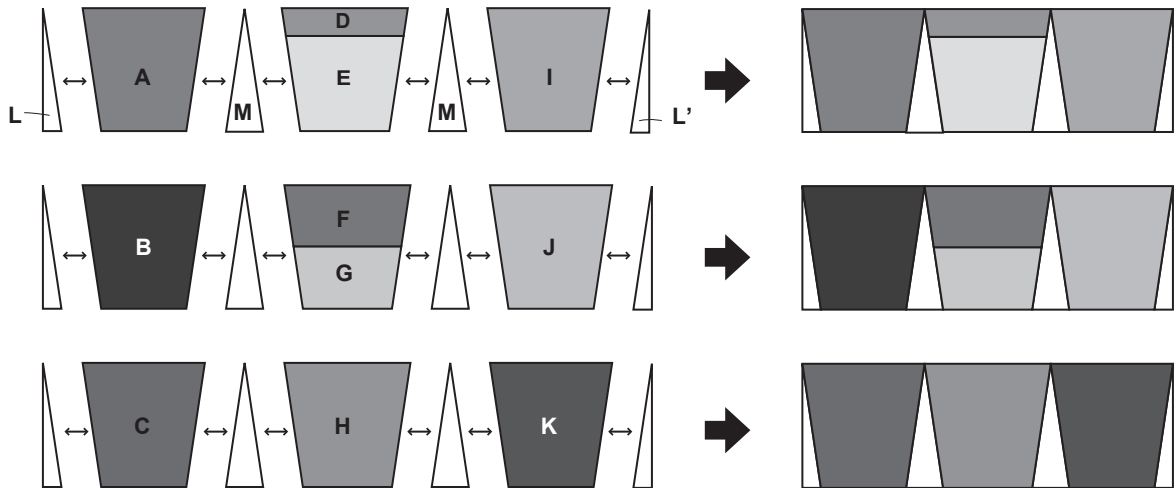

- Sew together the individual rows, and embroider on the handles
-

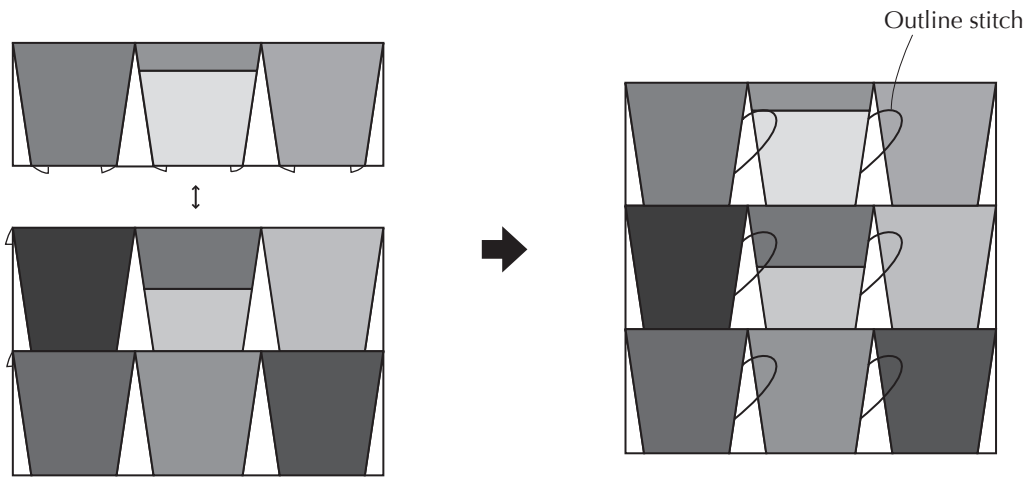

The task is completed.

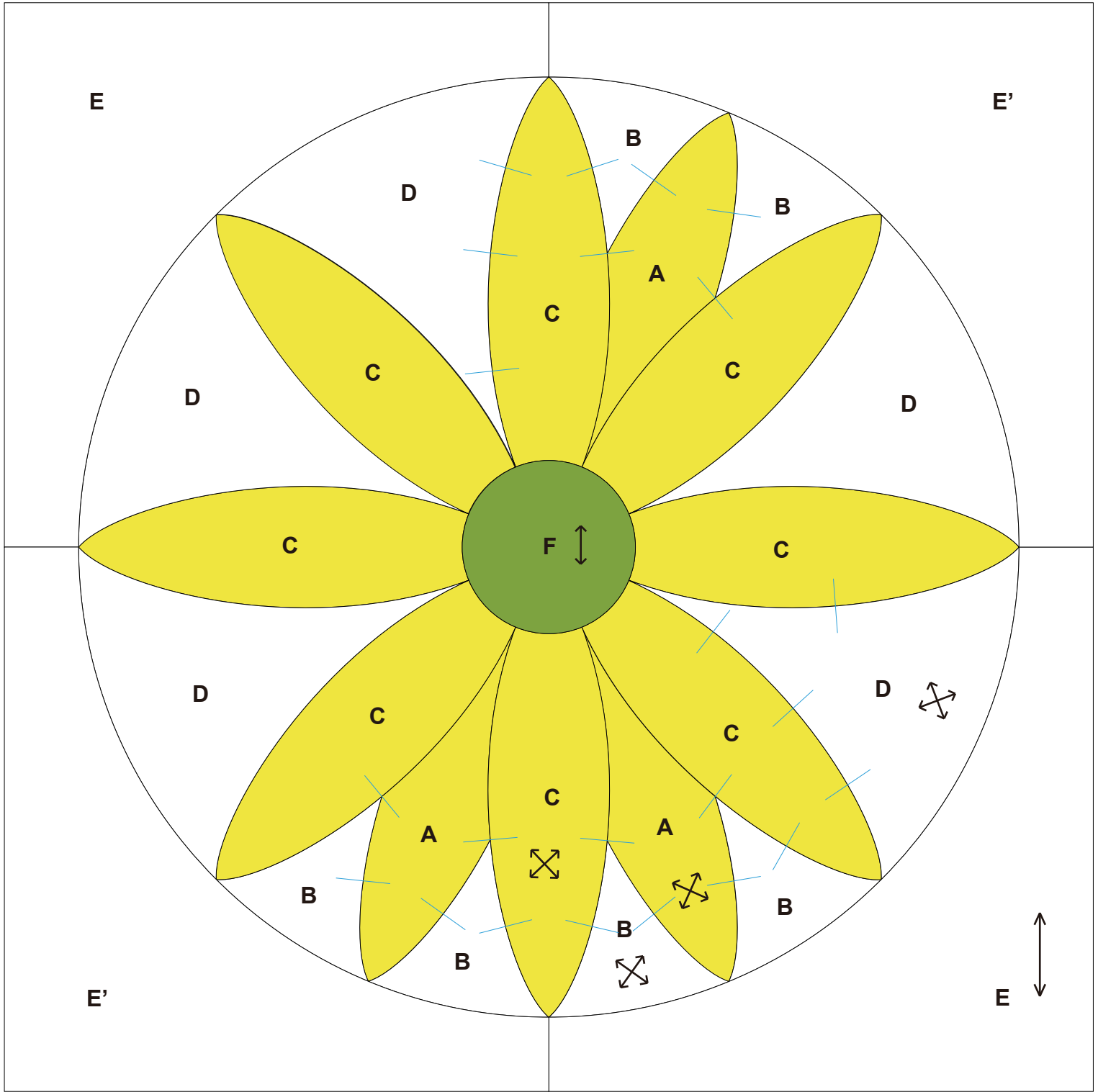
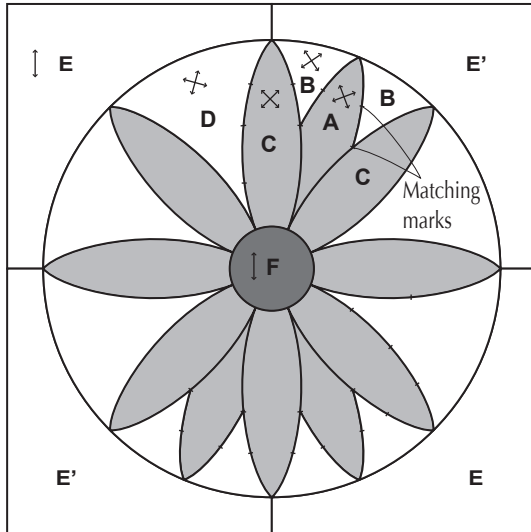

Illustration of finished item

←...Fabric grain
200 mm × 200 mm (8"×8")



How to make

- Sew together separately the three blocks of margaret petals (1, 2 and 3)

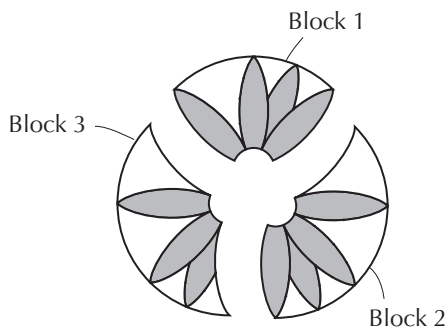

- 1 Sew together **A** and **B**, taking care of the matching marks.
Fold over the seam allowances on side **A**.

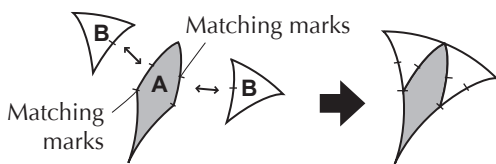

- 2 Sew on **C**.
Fold over the seam allowances on side **C**.

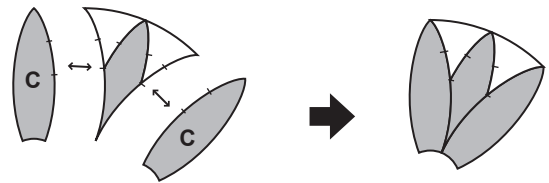

- 3 Sew on **D**.
Fold over the seam allowances on side **C**.

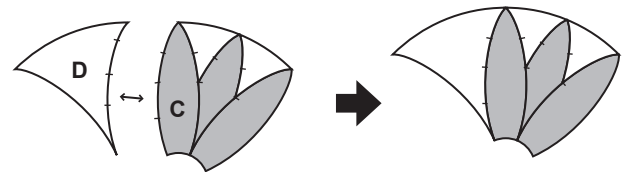

- 4 Sew on **C**.
Fold over the seam allowances on side **C**.

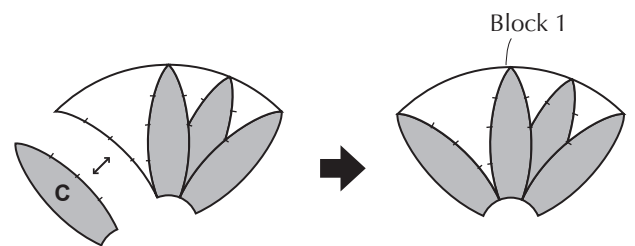

- 5 In the same way, make blocks 2 and 3, and then sew together blocks 1, 2 and 3.
Fold over the various seam allowances on side **C**.

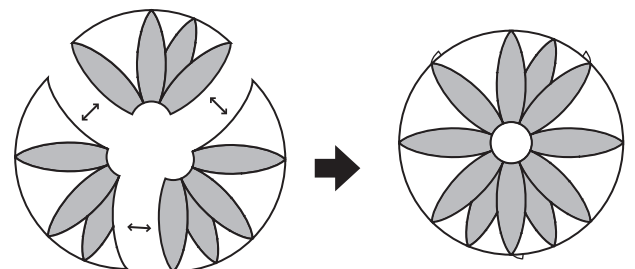

• **Make the background fabric**

1 Sew together E and E'. (Two pieces)

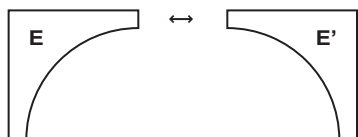

2 Sew together the upper and lower blocks.

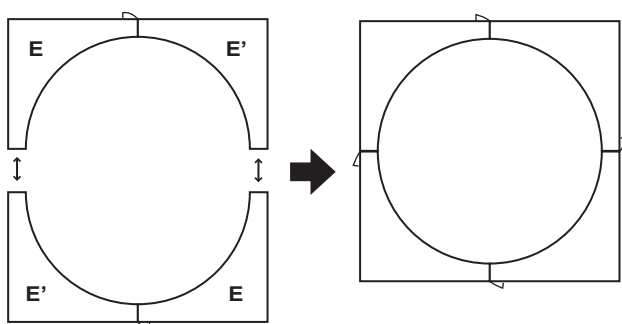

• **Sew together the margaret blocks and background fabric, dividing it into four times**

1 Align the matching marks, prick with a pin, and sew. (Use a pin to make fine holes to make it easier to sew.)
Fold over the seam allowances toward the center.

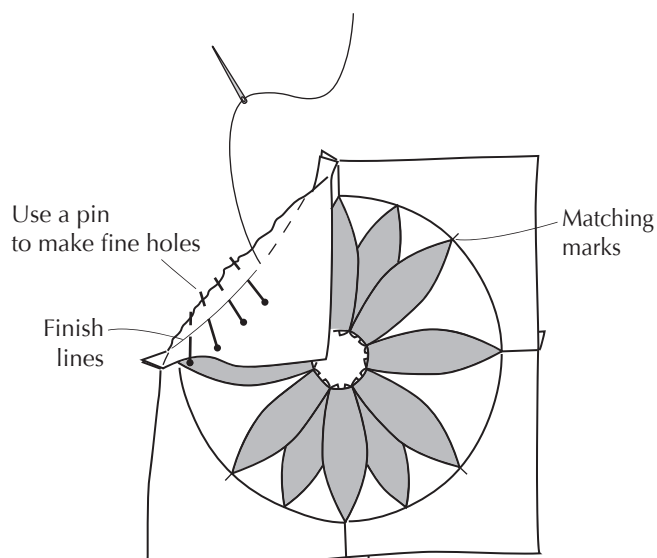

• **Appliqué the center of the flower**

1 Place the sewing pattern on the wrong side of the fabric, pull tight the running stitch on the seam allowance, and iron into shape.

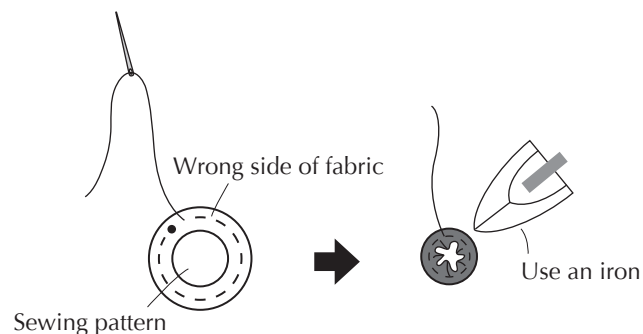

2 Appliqué into the center of the flower.

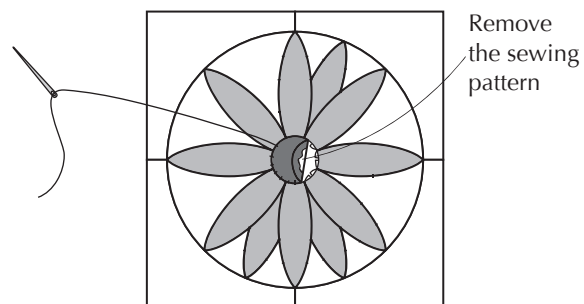

The task is completed.

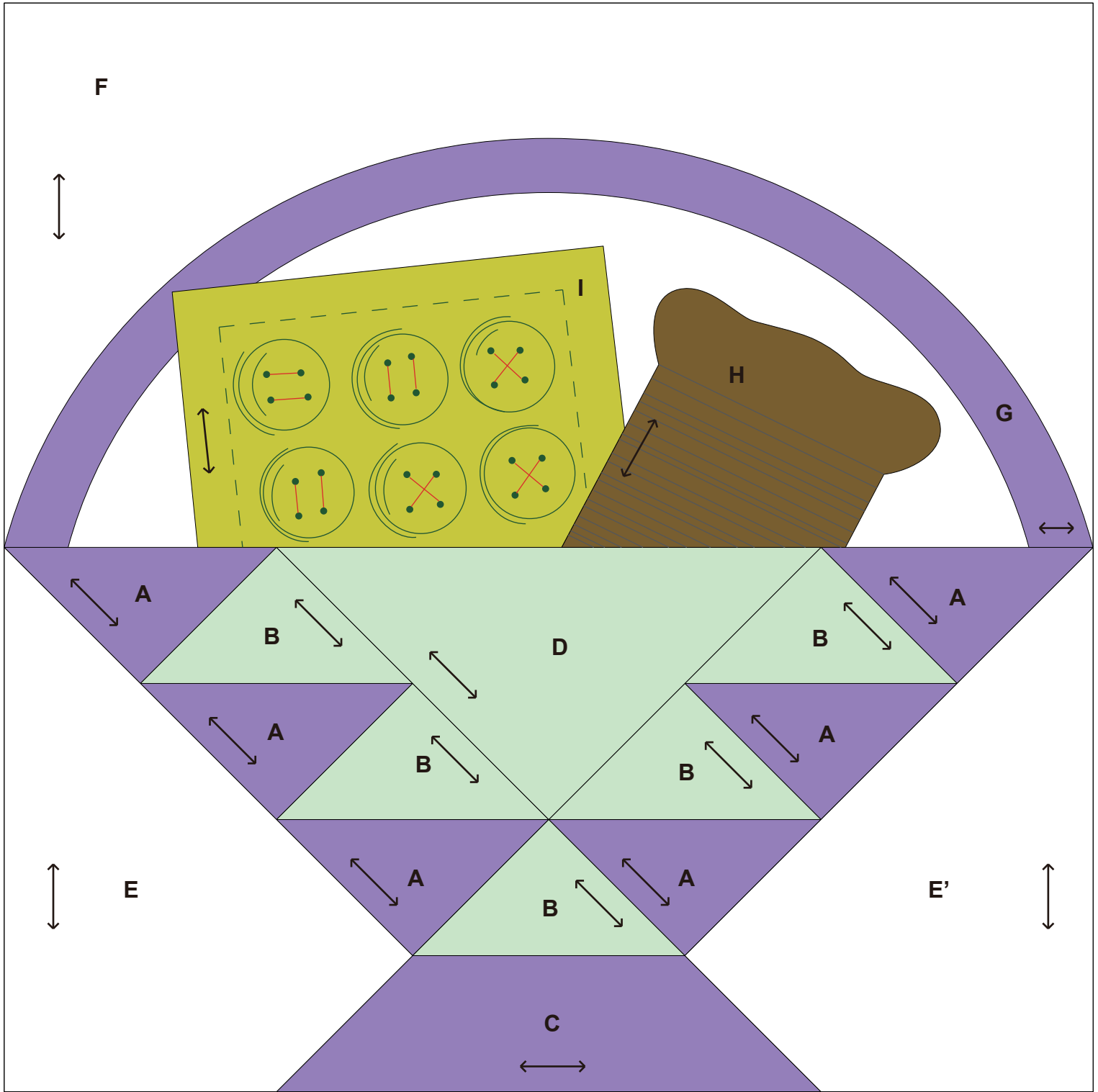

0 1 2 3 4 inches(")

0 50 100 mm

Illustration of finished item

←...Fabric grain
200 mm × 200 mm (8"×8")

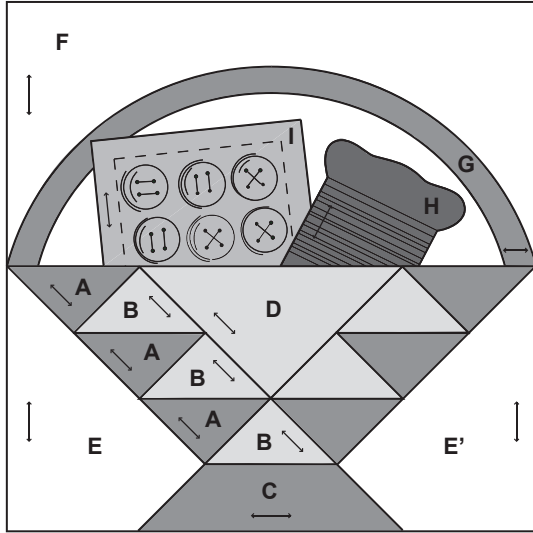

How to make

• Make the basket block

1 Stitch together **A** and **B**, and then sew together **E** and **E'** as shown in the figure.

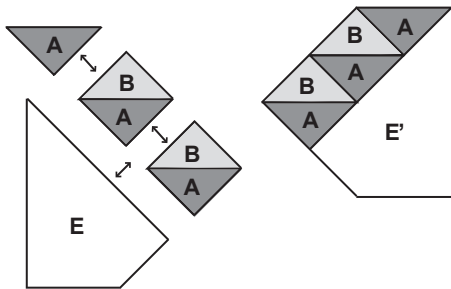

2 Stitch together **B** and **C**, and then sew on the left block.

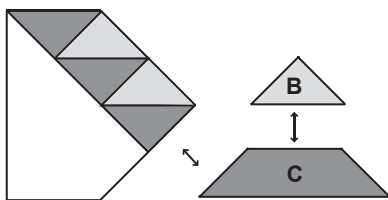

3 Sew together **D** and the right block.

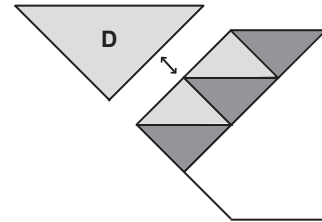

4 Sew together the left and right blocks.

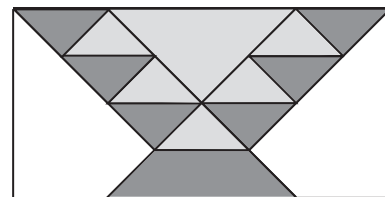
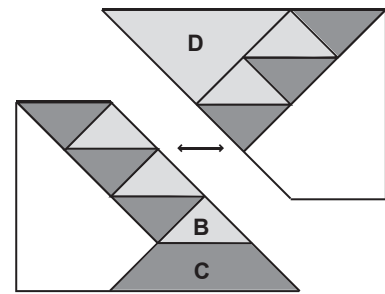

• Make the handle block

1 Make basket handle **G**.
Place the sewing patterns on the wrong side of the fabric, and iron them into shape.

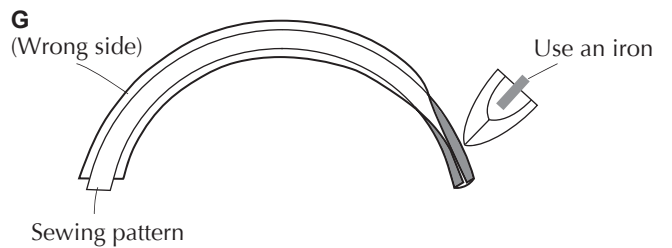

2 Make a mark on base fabric **F**, and appliqué handle **G**.
Next, appliqué **I** and **H**.

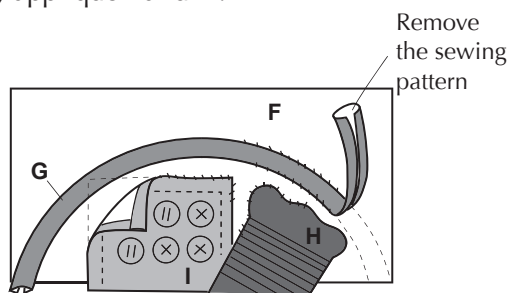

For curved lines,
make cuts in the seam
allowance, and appliqué

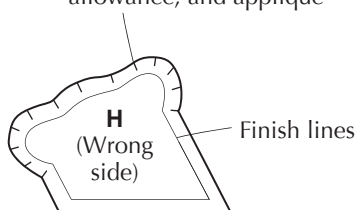

3 Embroider **I** and **H**.

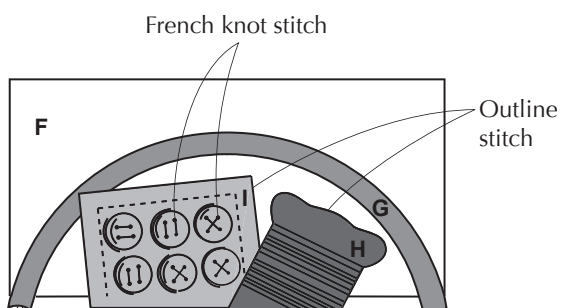

• Sew together the upper and lower blocks

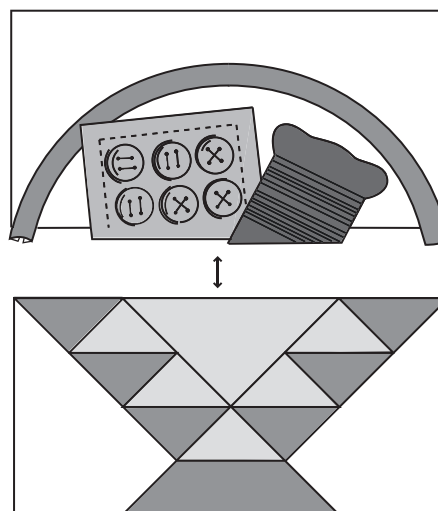

The task is completed.

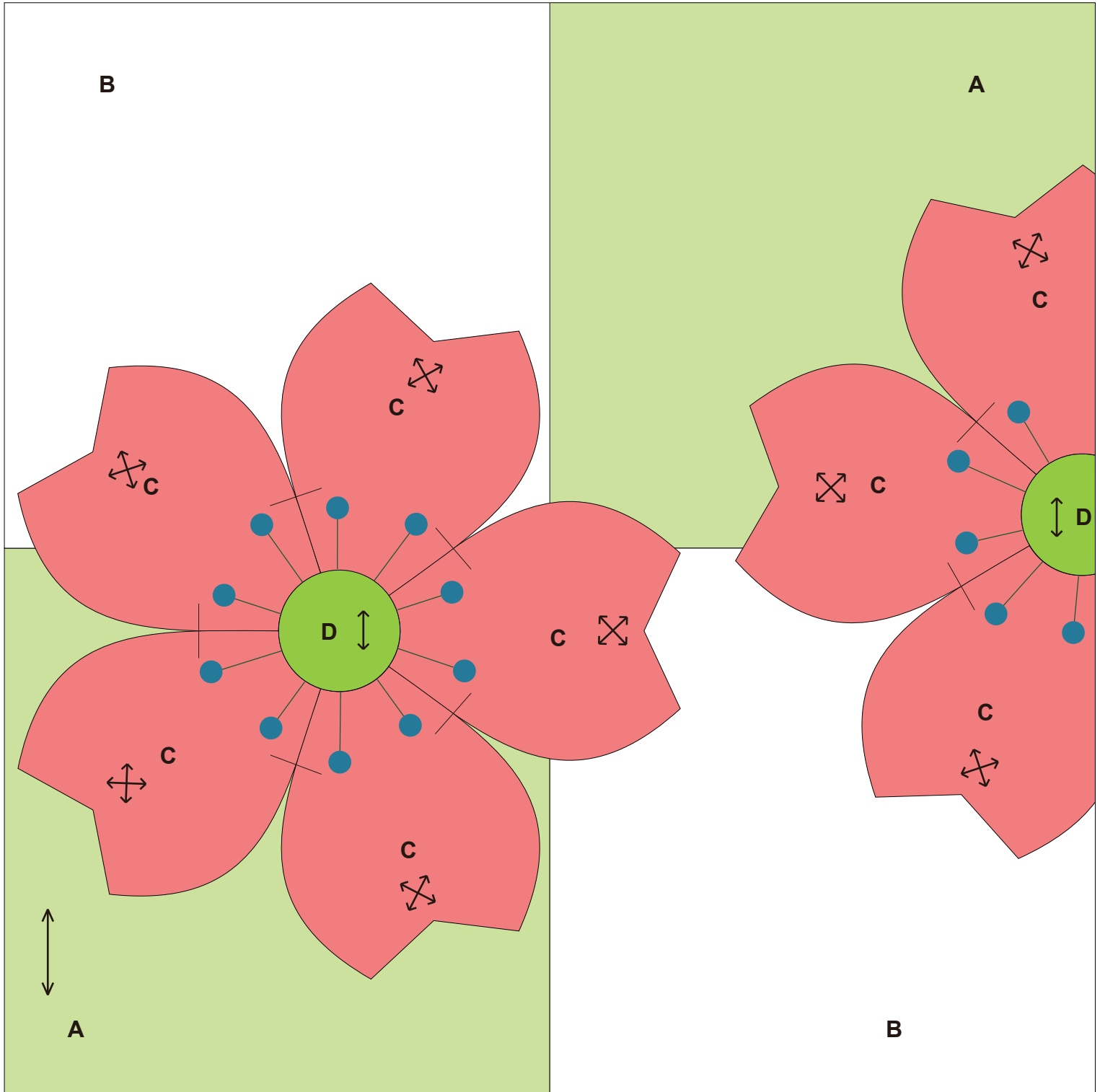

0 1 2 3 4 inches(")

0 50 100 mm

Illustration of finished item

←...Fabric grain
200 mm × 200 mm (8"×8")

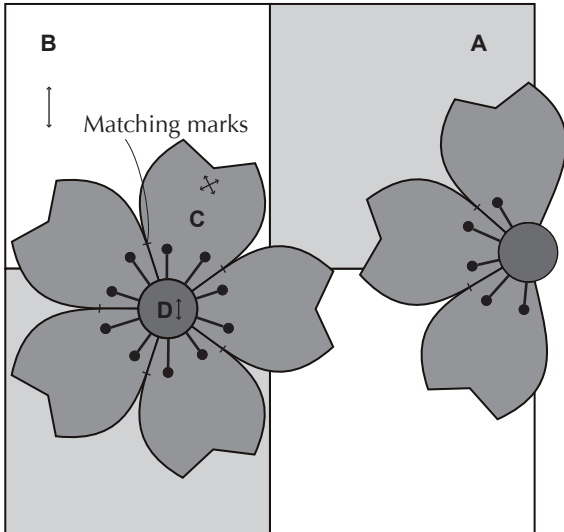

How to make

• Appliqué the cherry blossoms

- 1 Sew the petals together.
Sew together, taking care of the mark ends of the matching marks, as shown in the figure.
Fold over the seam allowances to one side.

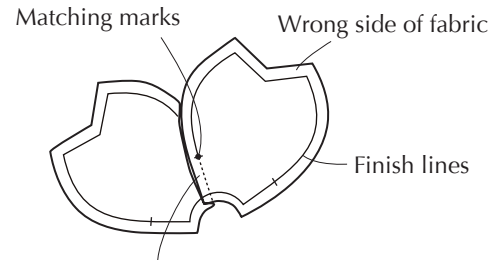

Fold over the seam allowances to one side

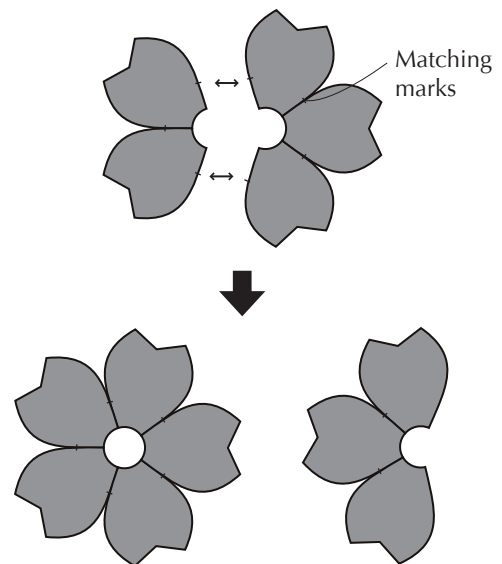

- 2 Place the sewing patterns on the wrong side of the flower petals, and iron them into shape.
(If you make cuts in the flower petals right to the end, they will have a more attractive finish.)

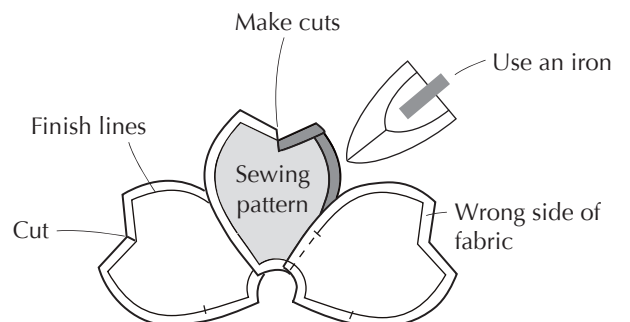

• Make the base material

1 Sew together A and B.

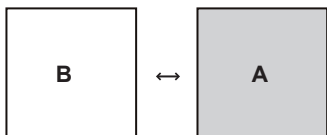

2 Sew together the upper and lower blocks.

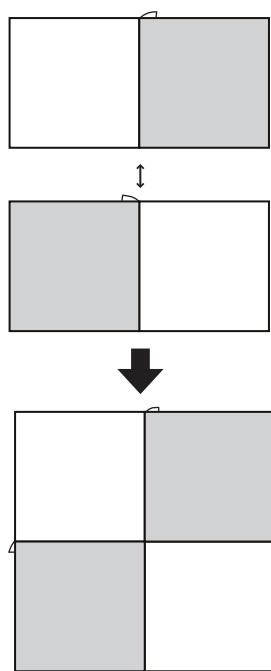

• Appliqué

1 Make a mark on base material, tack the thread and appliqué the flower petals. Cut off the pieces in areas that stick out from the base material.

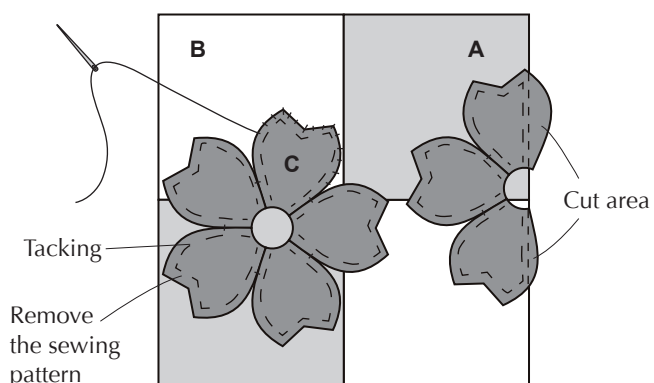

2 Embroider the petals.

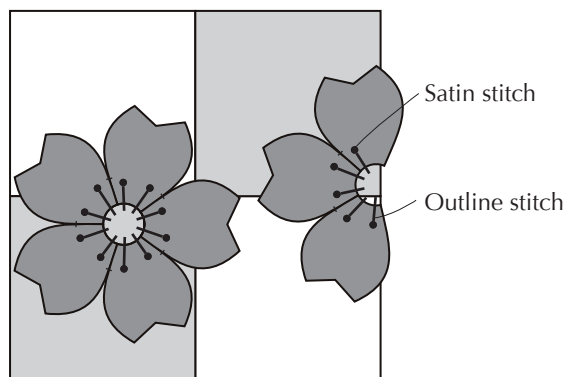

3 Appliqué the center of the flower. Place the sewing pattern on the wrong side of fabric D, and make and pull tight a running stitch on the seam allowance. Use an iron to make the shape.

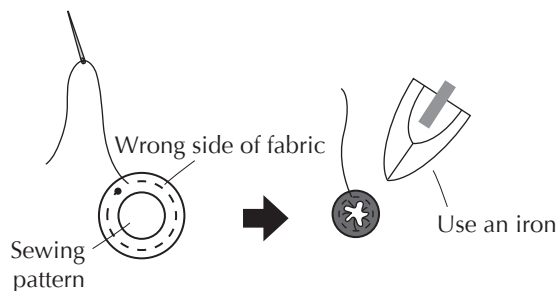

4 Make mark and appliqué.

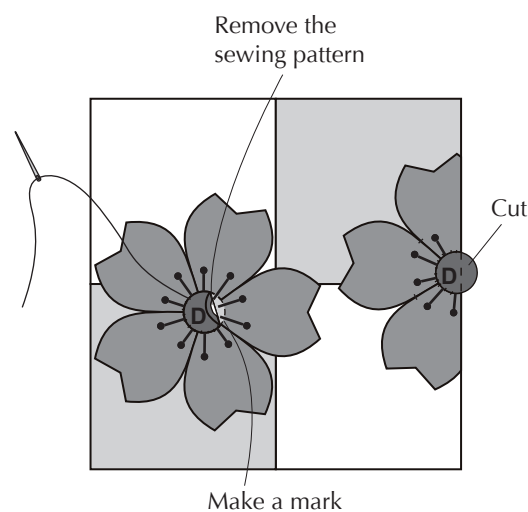

The task is completed.

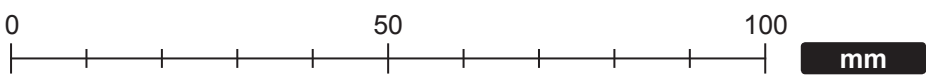
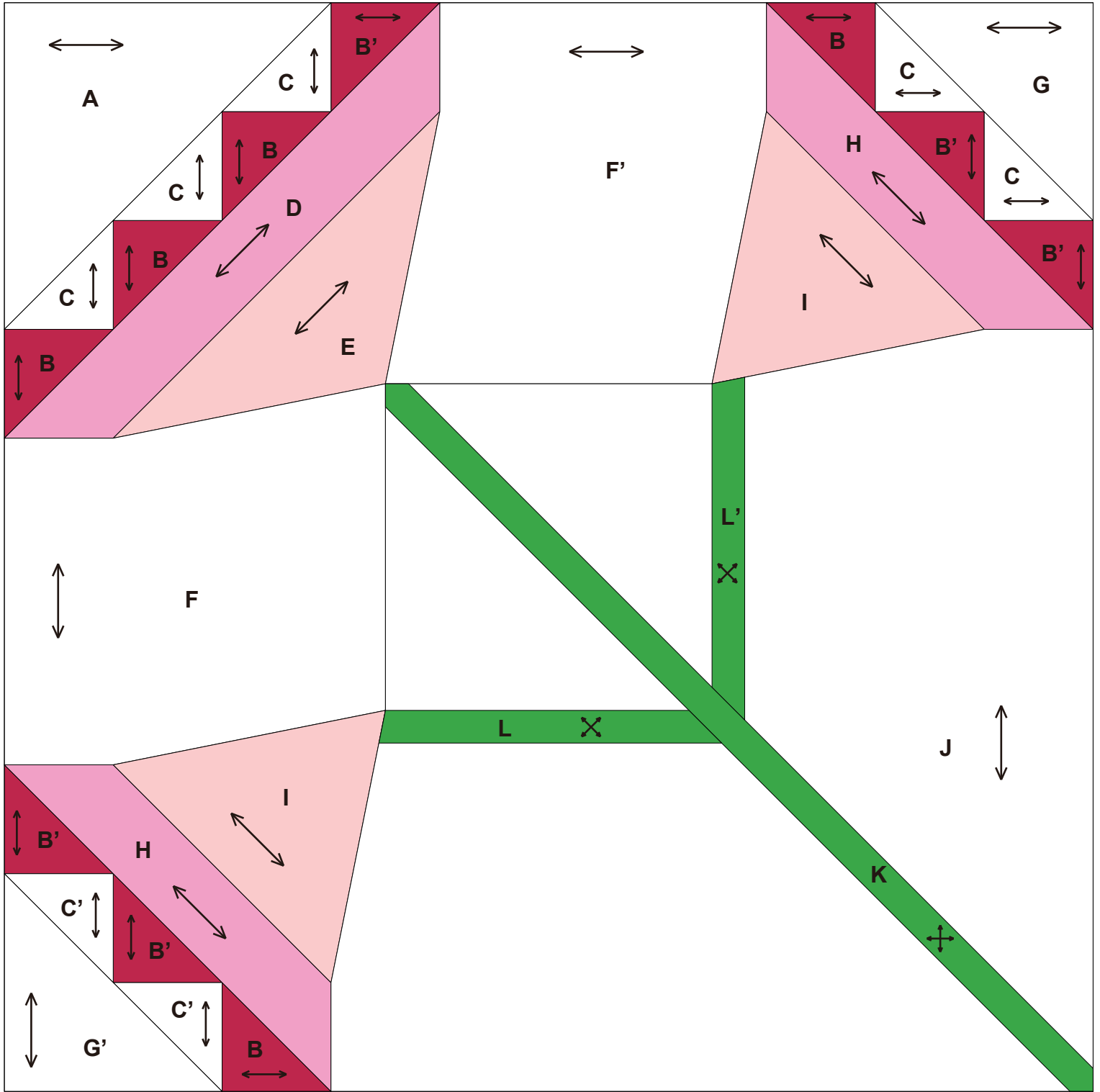

30 Fringed pink flower

1/2

Illustration of finished item

←...Fabric grain
●...Mark ends
200 mm × 200 mm (8"×8")

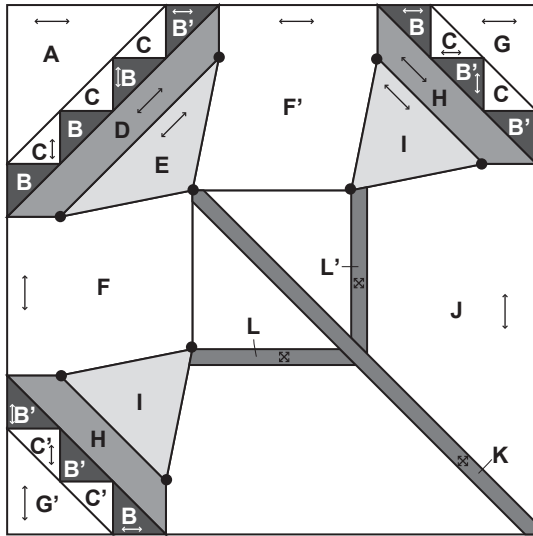

How to make

• Make the flower in the center

1 Stitch together **B**, **B'** and **C**, and then sew on **A**.

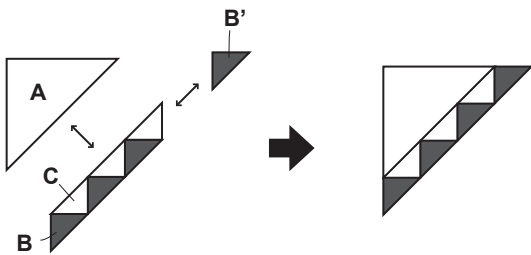

2 Stitch together **D** and **E**, taking care of the mark ends.

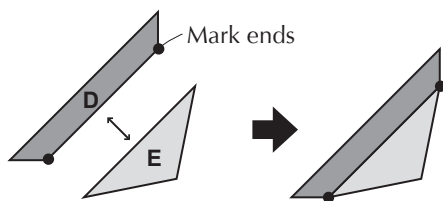

3 Sew together, as shown in the figure.

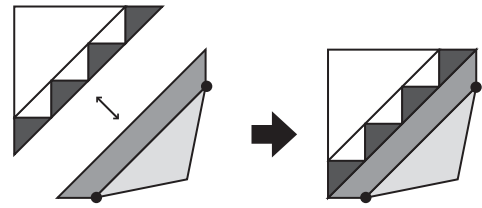

• Make the left and right flowers (two pieces)

1 Stitch together **B**, **B'** and **C**, and then sew on **G**.

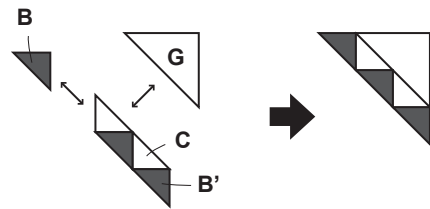

2 Stitch together **H** and **I**, taking care of the mark ends.

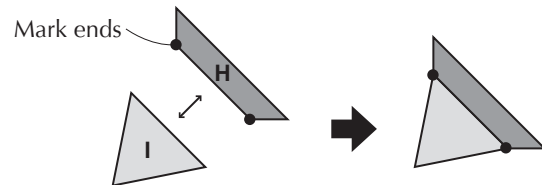

3 Sew together, as shown in the figure.
In the same way, make the flower on the left side.

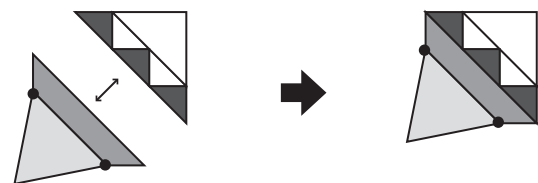

• Make the stem block

1 Place the sewing patterns on the wrong side of the fabric for **L**, **L'** and **K**, and iron them into shape.

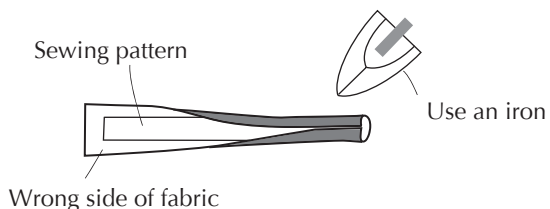

2 Appliqué the stem on top of **J**. First appliqué **L** and **L'**, and then **K**.

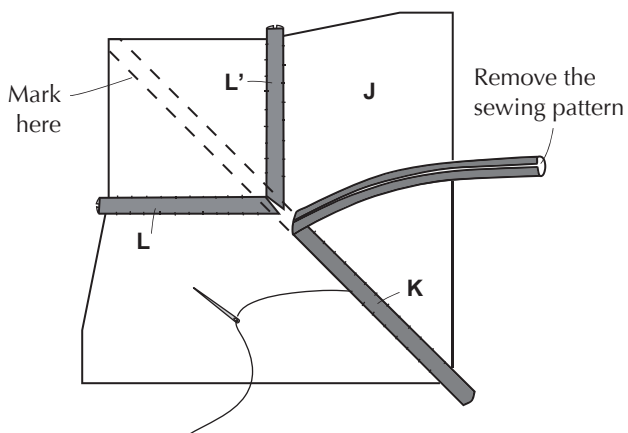

• Sew together the overall design

1 Sew together the flowers, **F** and **F'**, taking care of the mark ends.

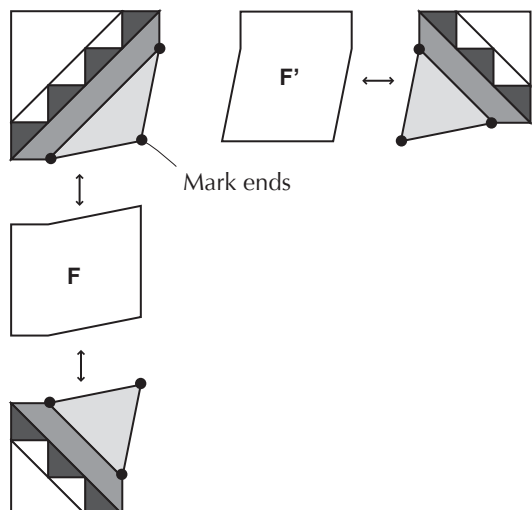

2 Sew together the flower and stem blocks, taking care of the mark ends.

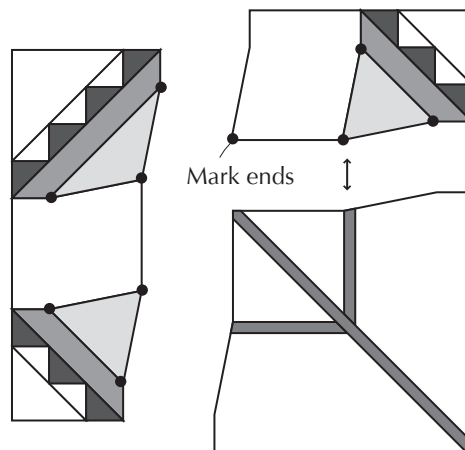

3 Sew together the left and right blocks, taking care of the mark ends.

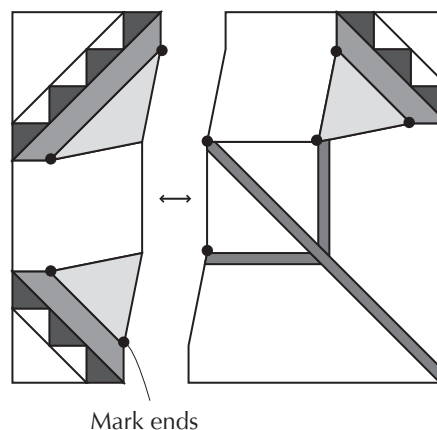

The task is completed.

31

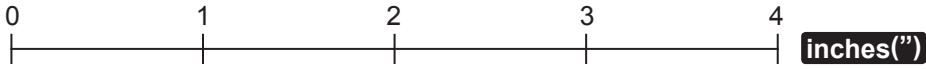
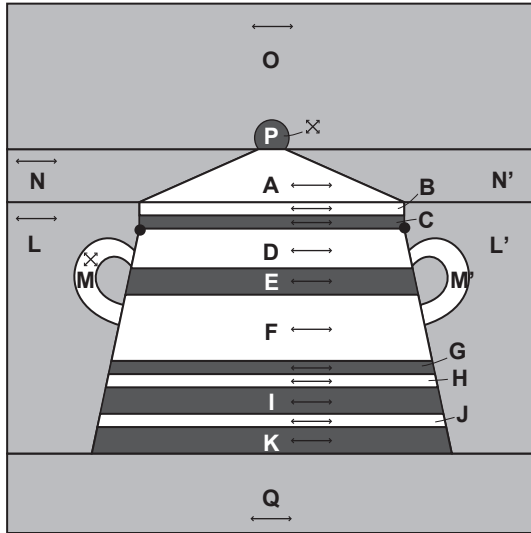

Illustration of finished item

←...Fabric grain
 ●...Mark ends
 200 mm × 200 mm (8"×8")



How to make

• Make the lid block

- 1 Place the sewing pattern on the wrong side of fabric **P**, pull tight the running stitch on the seam allowance, and iron into shape. Appliqué **P** on top of **O**.

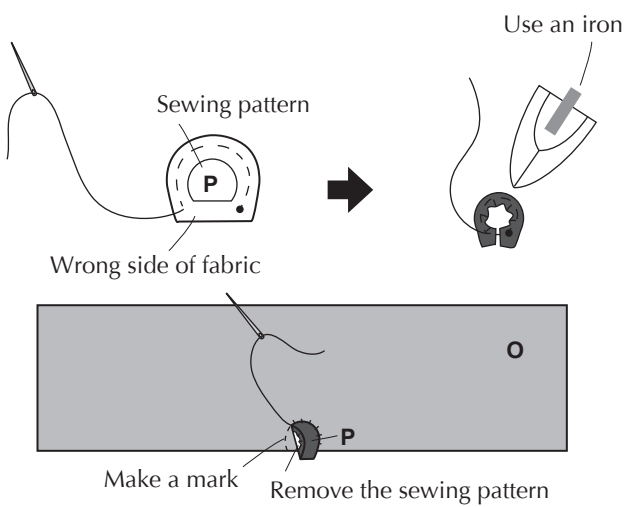

- 2 Sew together **A**, **N** and **N'**.

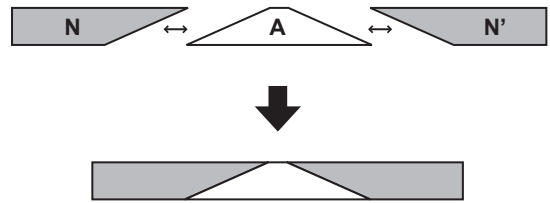

- 3 Sew together, as shown in the figure.

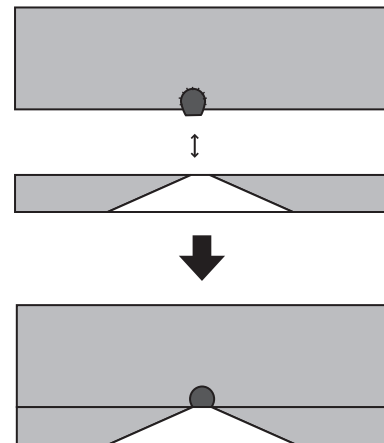

• **Make the pot body block**

1 Stitch together **B, C, D, E, F, G, H, I, J** and **K**, taking care of the **C** mark ends. Fold over the seam allowances toward the darker-colored fabrics.

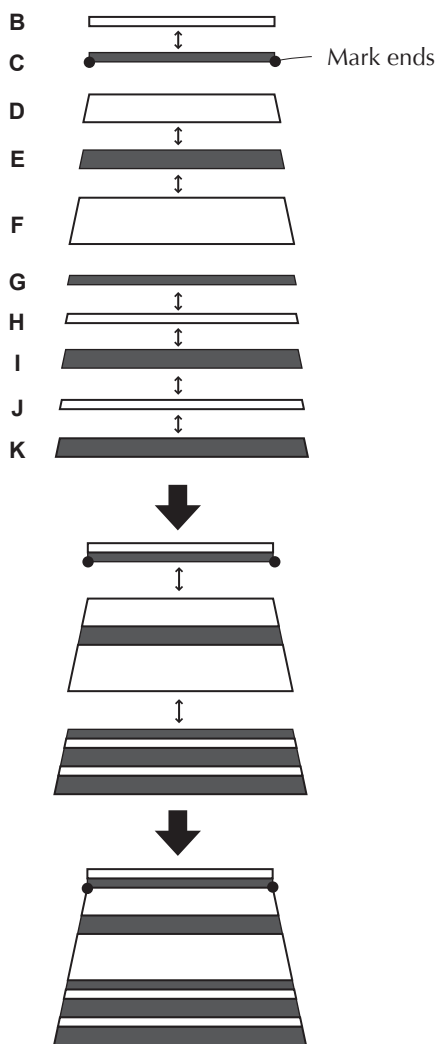

2 Place the sewing patterns on the wrong side of the fabric for handles **M** and **M'**, and iron them into shape. Place handle **M** on top of **L**, and appliqué handle **M'** on top of **L'**.

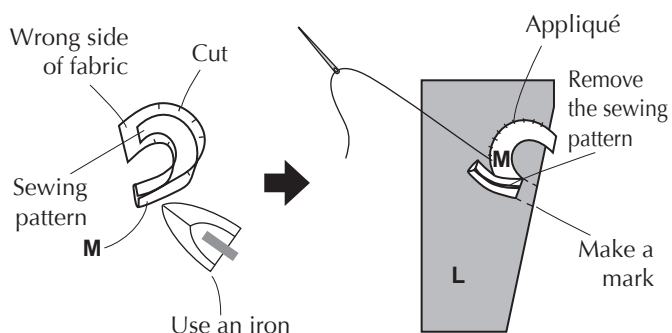

3 Sew together as shown in the figure, taking care of the mark ends.

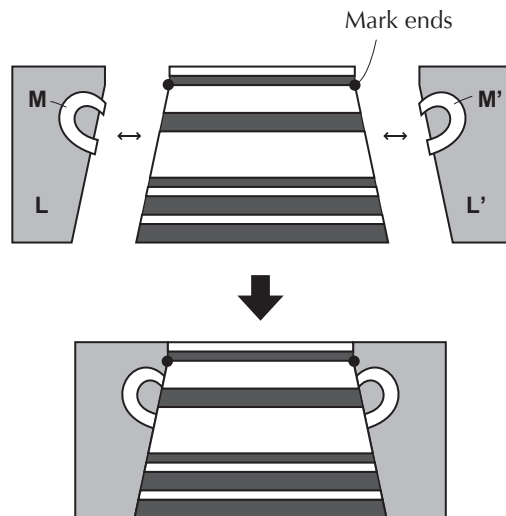

• **Sew together the overall design**

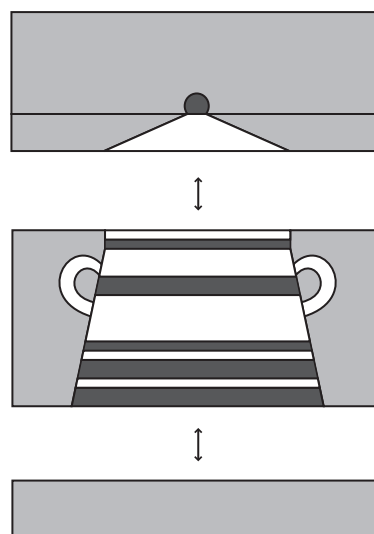

The task is completed.

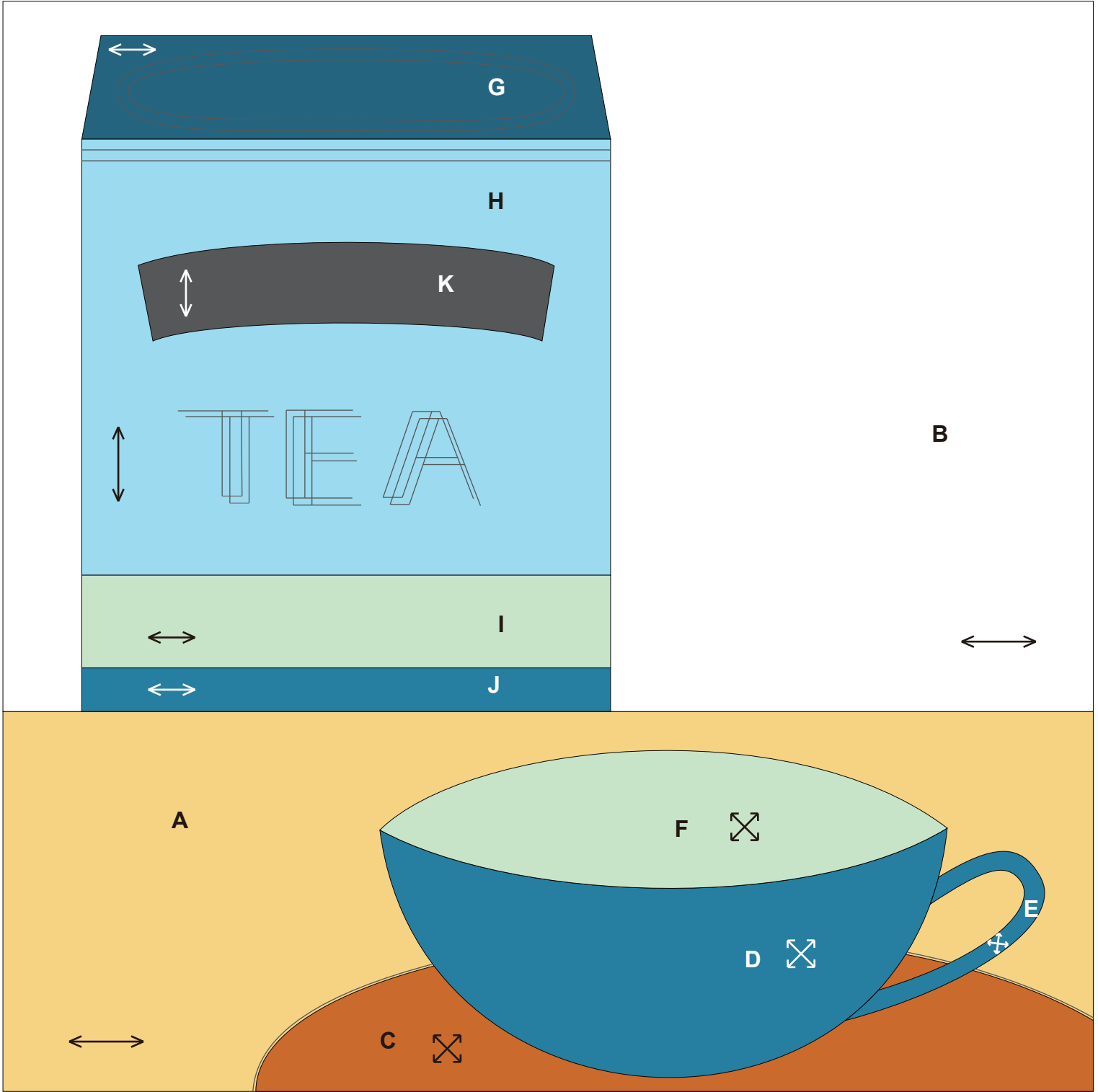

0 1 2 3 4 inches(")

0 50 100 mm

Illustration of finished item

←...Fabric grain
200 mm × 200 mm (8"×8")

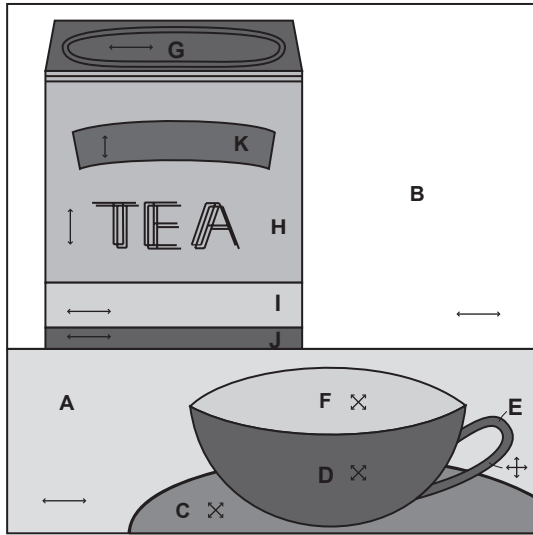

How to make

- Sew together separately the cup and the tea can

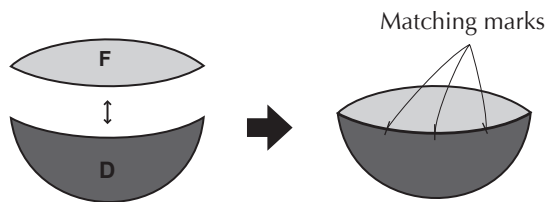

Note: The matching marks make it easier to sew the pieces together.

- 1 Sew together the tea can as shown in the figure, and appliqué K.

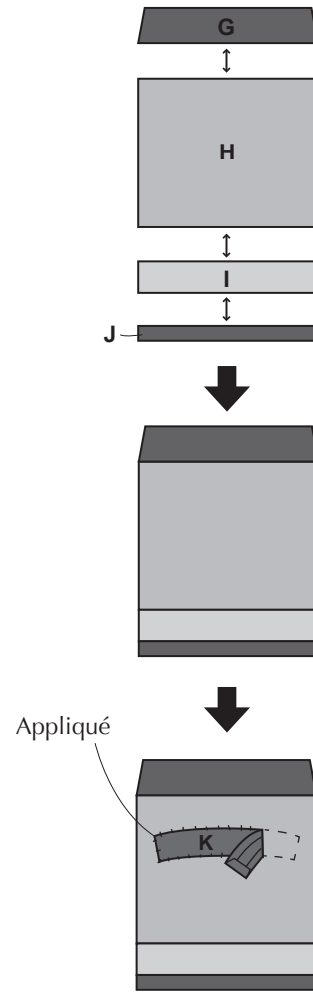

- Make a mark on base material B, and appliqué the tea can

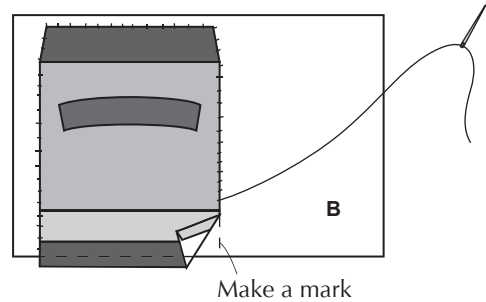

• Sew together base material B and A

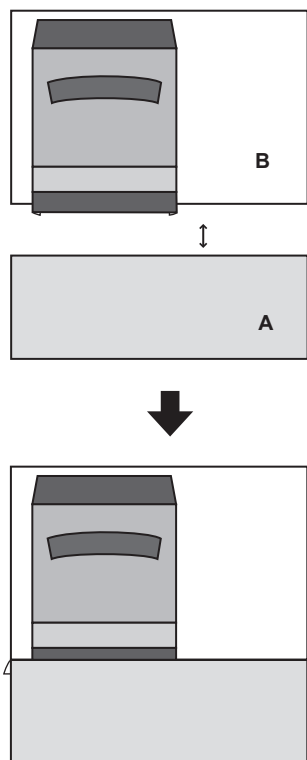

• Appliqué the saucer and cup

- 1 Appliqué saucer C, and then make a mark on cup handle E and appliqué. Place the sewing pattern on the wrong side of the fabric for handle E, and iron it into shape.

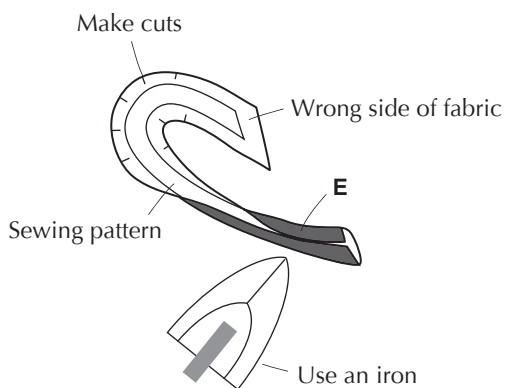
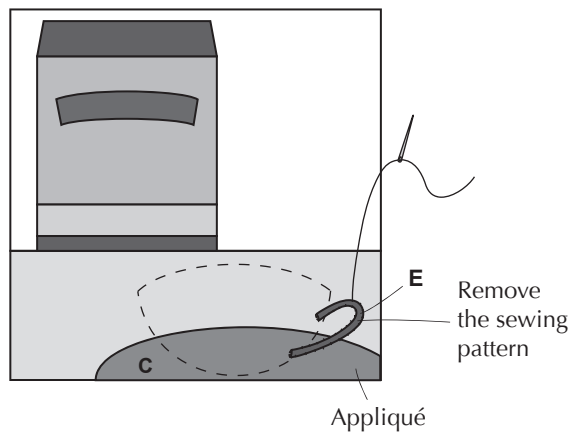

- 2 Appliqué the cup, and embroider the tea can and the saucer.

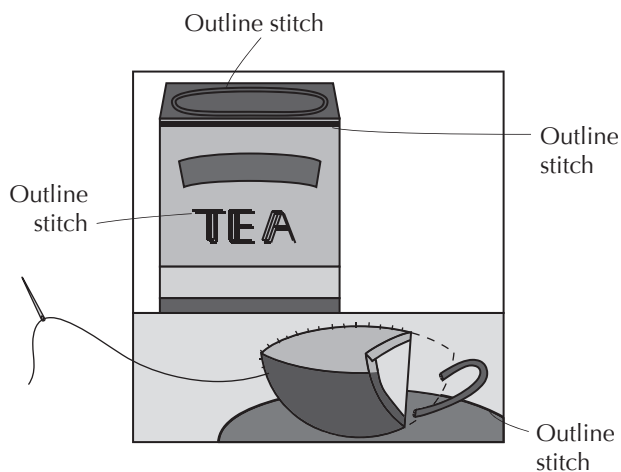

The task is completed.

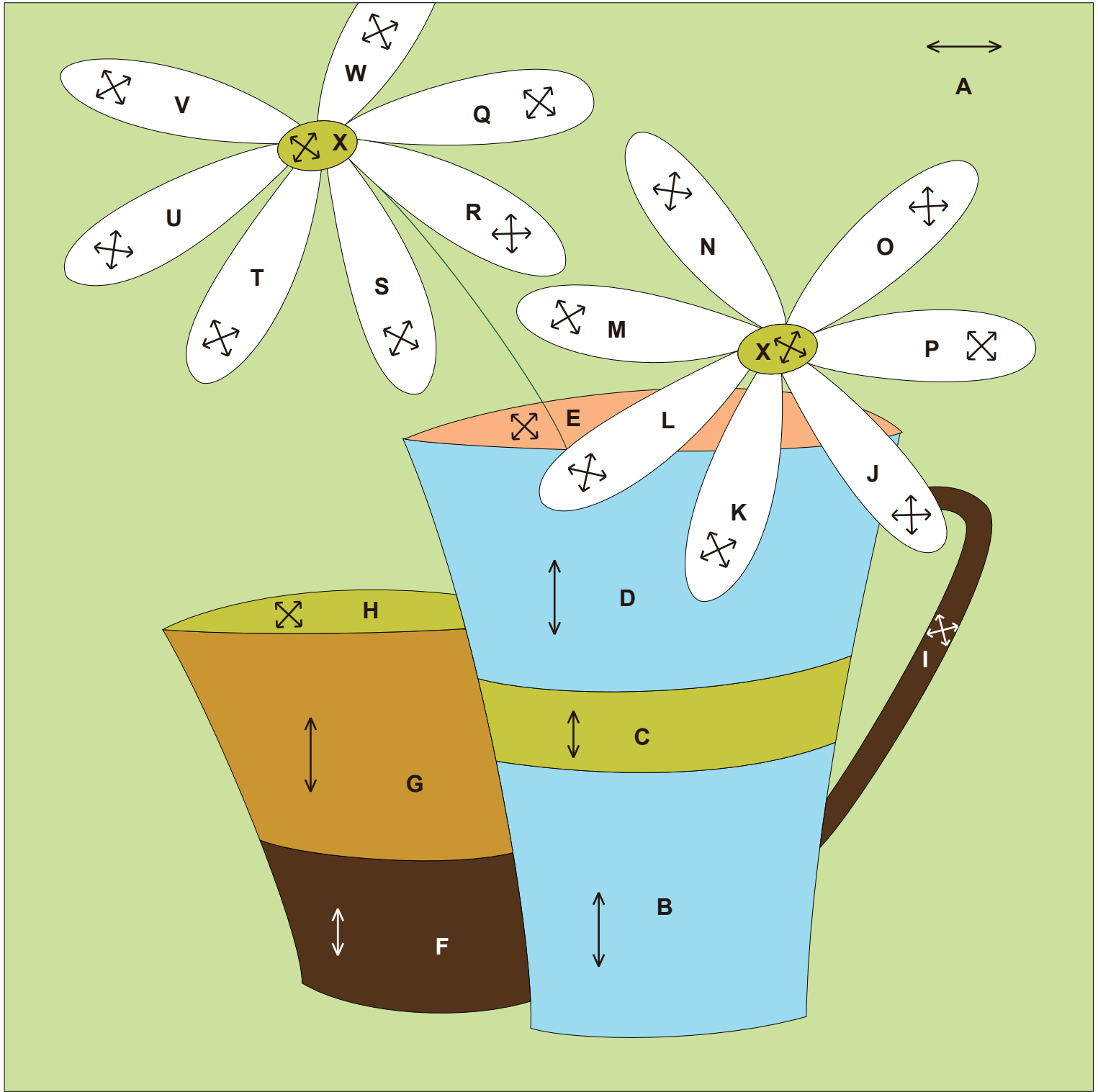

0 1 2 3 4 inches(")

0 50 100 mm

Illustration of finished item

←...Fabric grain
200 mm × 200 mm (8"×8")

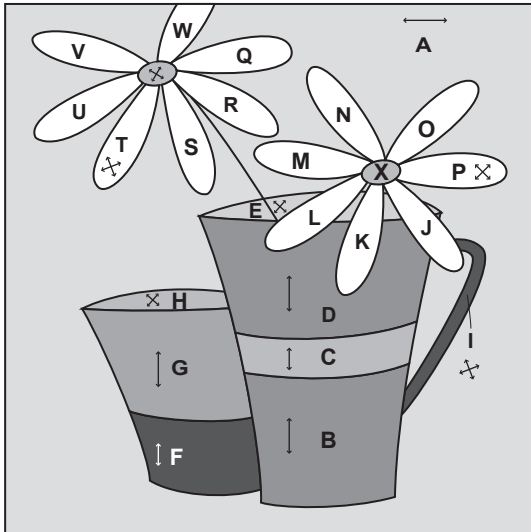

How to make

- Sew together separately the large and small cups

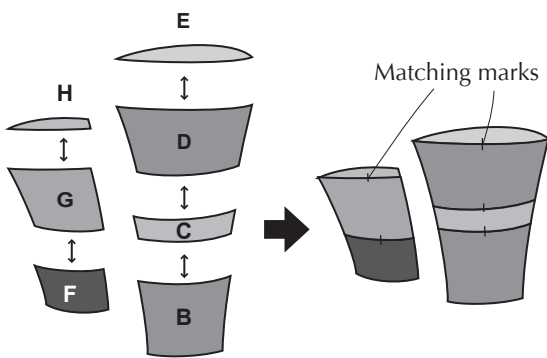

Note: The matching marks make it easier to sew the pieces together.

- Make a mark on base material A, and appliqué the cups

- 1 Make a mark on large cup handle I, and appliqué. Place the sewing pattern on the wrong side of the fabric for handle I, and iron it into shape.

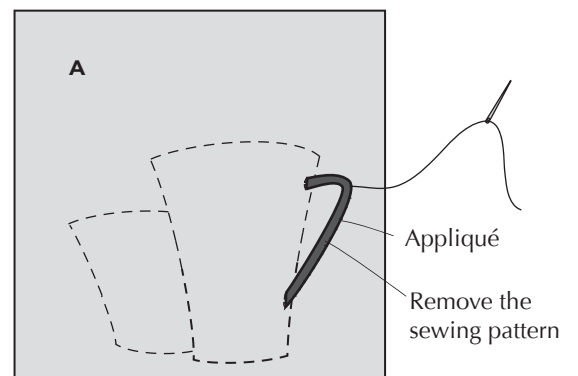
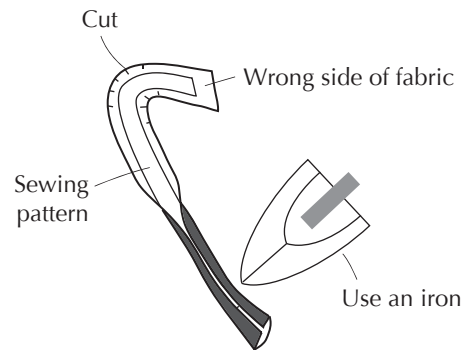

2 Appliqué the small cup and large cup, in that order.

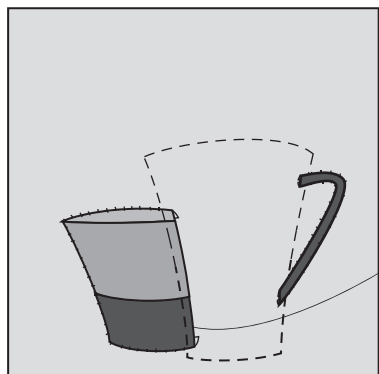

Do not appliqué on the area where the fabric is doubled up (Do not fold in the seam allowance)

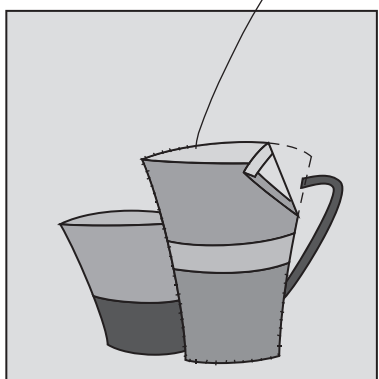

• **Make 14 margaret flower petal pieces and two pieces for the centers of the flowers**

1 For the flower petals, place the sewing patterns on the wrong side of the fabric, and iron them into shape. For the center of the flower, make a running stitch in the seam allowance and pull tight.

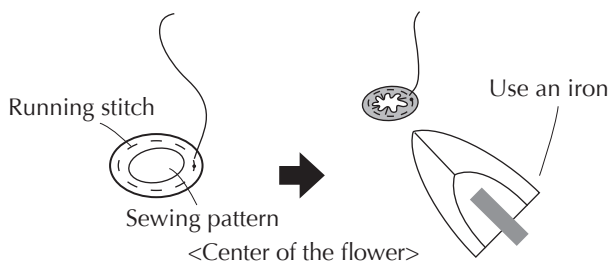
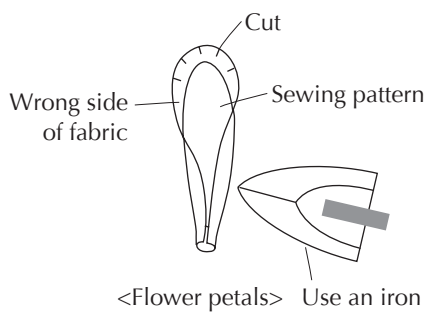

• **Appliqué the flower petals and the centers of the flowers**

1 First make marks and embroider the stem, and then appliqué the flower petals.

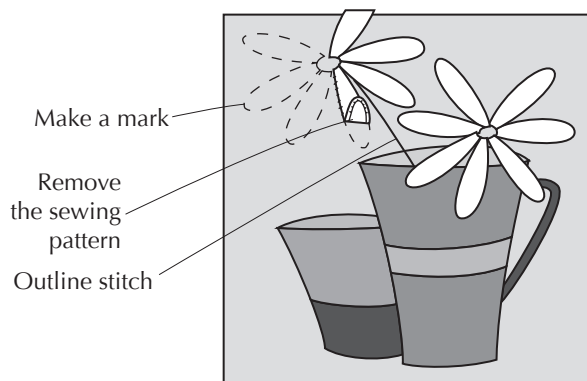

- 2** Appliqué the flower center into the center of the flower.
Cut off the flower petals where they stick out from the base material.

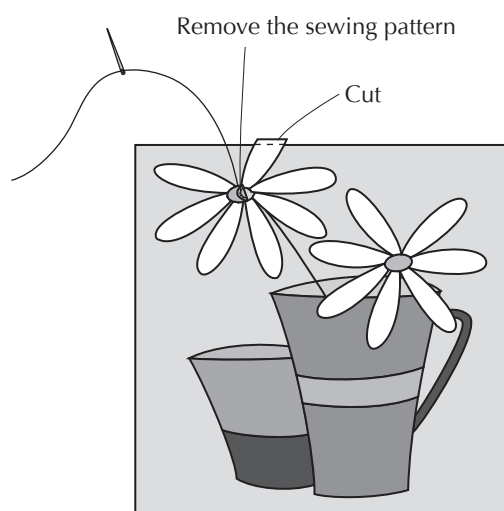

The task is completed.

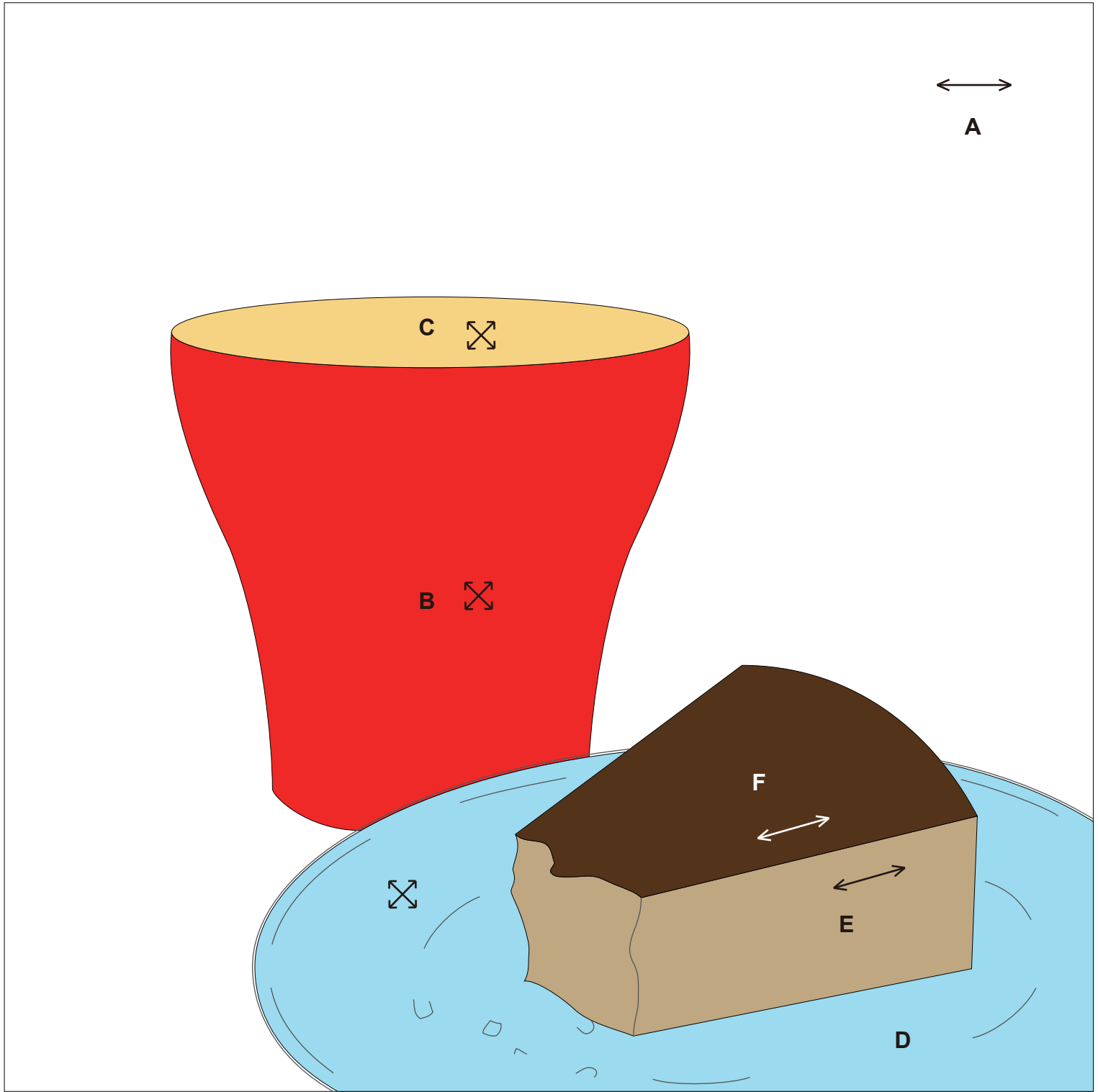

0 1 2 3 4 inches(")

0 50 100 mm

34 Cake

Illustration of finished item

←...Fabric grain
 ●...Mark ends
 200 mm × 200 mm (8"×8")

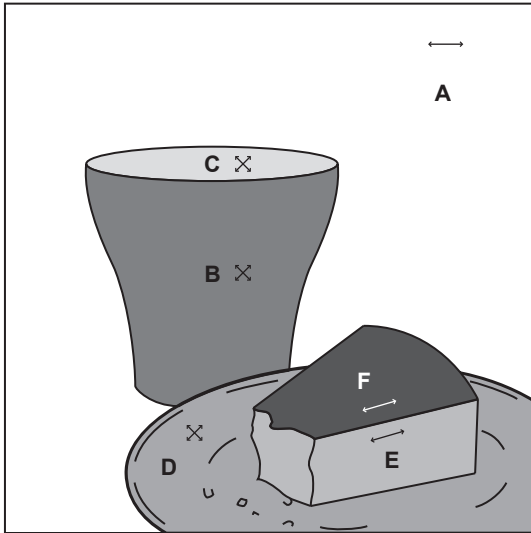

How to make

• Sew together the cup

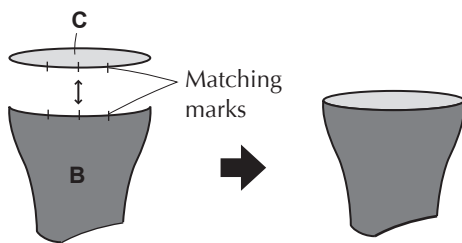

Note: The matching marks make it easier to sew the pieces together.

• Sew the set-in seam, taking care of the mark ends on the corners of the cake

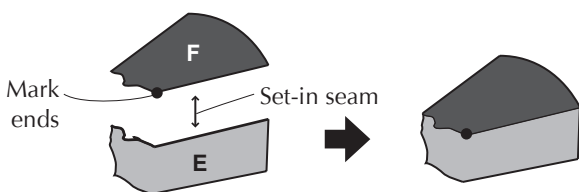

• Make a mark on base material A, and appliqué

1 Appliqué first the cup, then the plate, and then the cake.

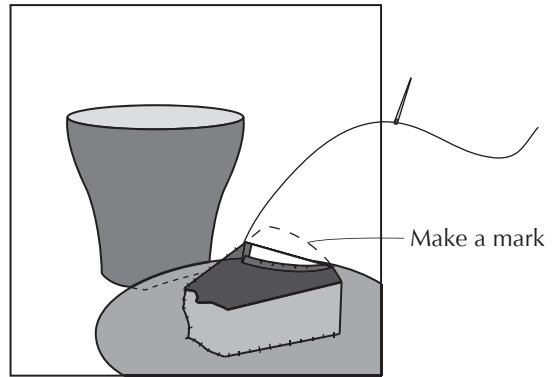

• Embroider the cake and plate

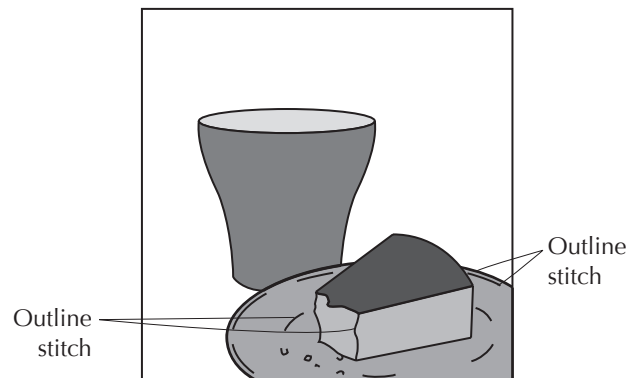

The task is completed.

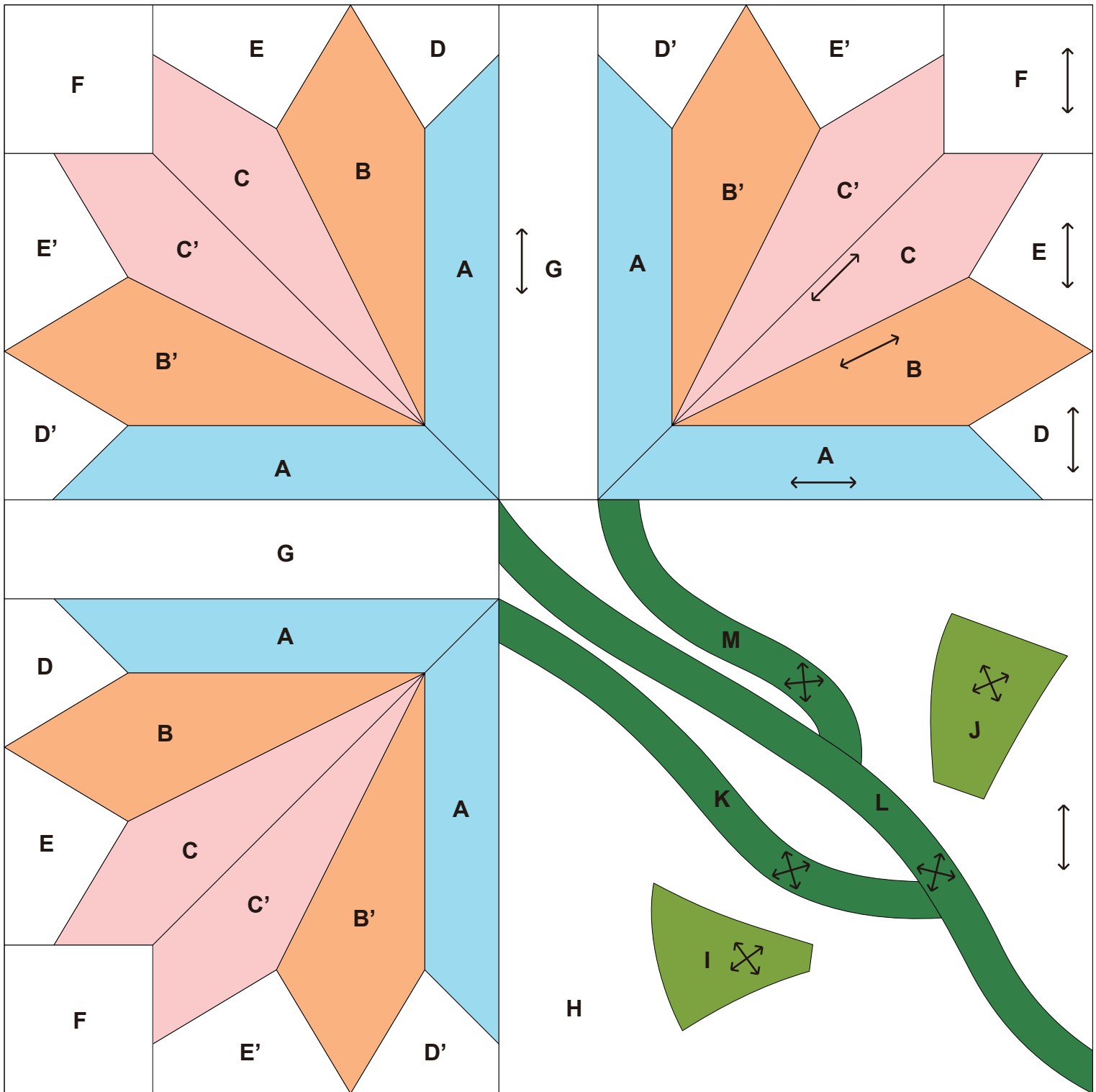

0 1 2 3 4 inches(")

0 50 100 mm

Illustration of finished item

←...Fabric grain
●...Mark ends
200 mm × 200 mm (8"×8")

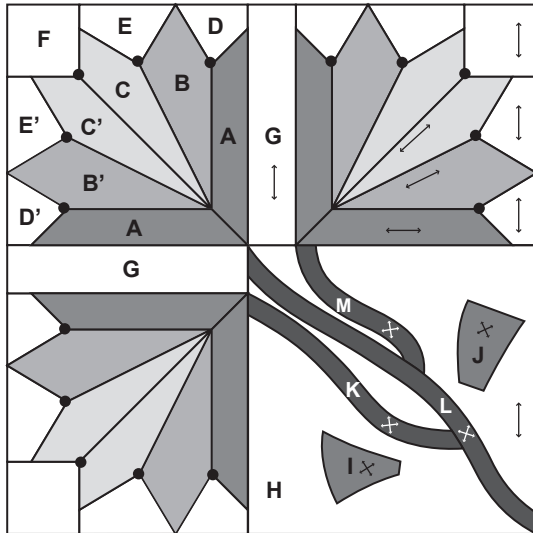

How to make

• Make flower blocks (three pieces)

1 Stitch **A**, **B** and **C** together, taking care of the mark ends.

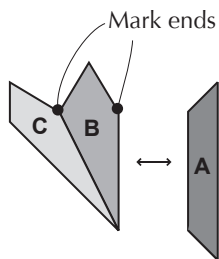

2 Make set-in seams on **E** and **D**.

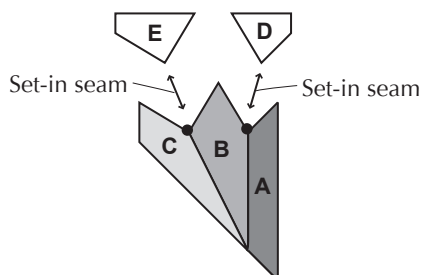

3 In the same way, sew together **A'**, **B'** and **C'**, and make set-in seams on **D'** and **E'**.

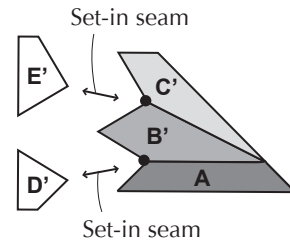

4 Sew together the two symmetrical blocks, taking care of the mark ends.

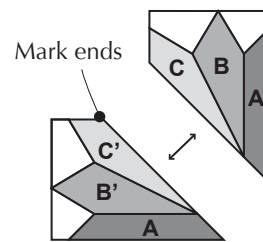

5 Make a set-in seam on **F**.

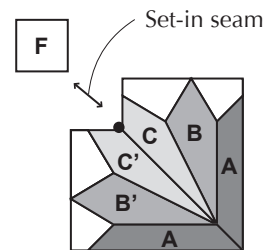

• Make the stem and leaf blocks

1 Place the sewing patterns on **L**, **M** and **K** for the stem, and **I** and **J** for the leaves, and iron them into shape.

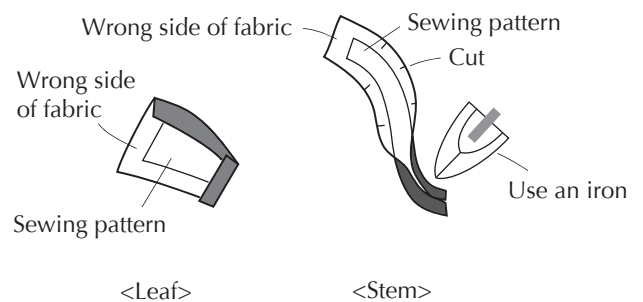

- 2** Make a mark on base material **H**, and appliqué the stem and leaves.
For the stem, appliqué **M**, **K** and **L**, in order.

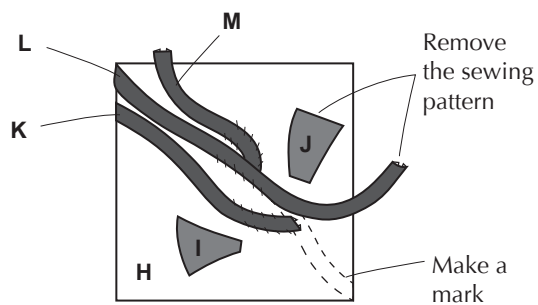

• Sew together the flower block and **G**

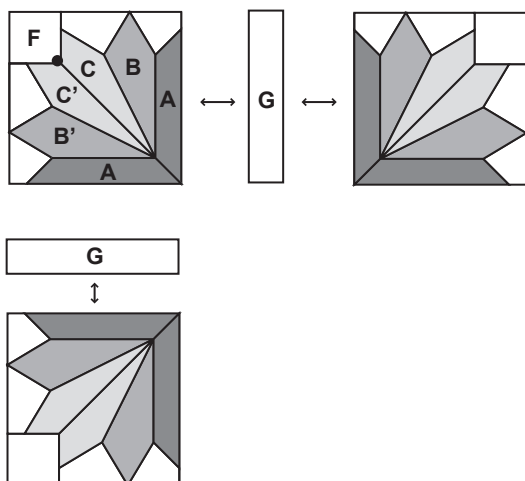

• Sew together the stem and leaf blocks

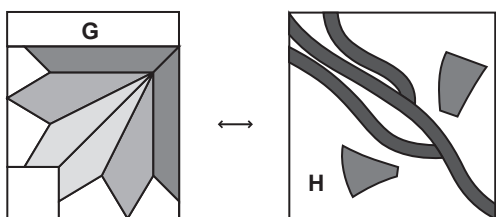

• Sew together the upper and lower blocks

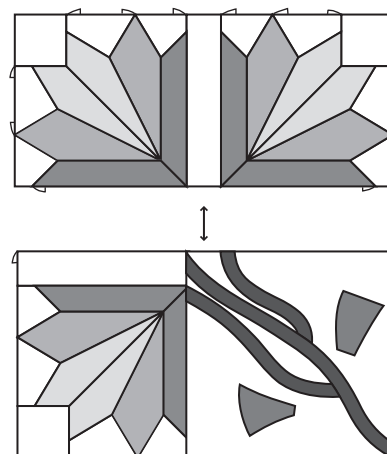

The task is completed.

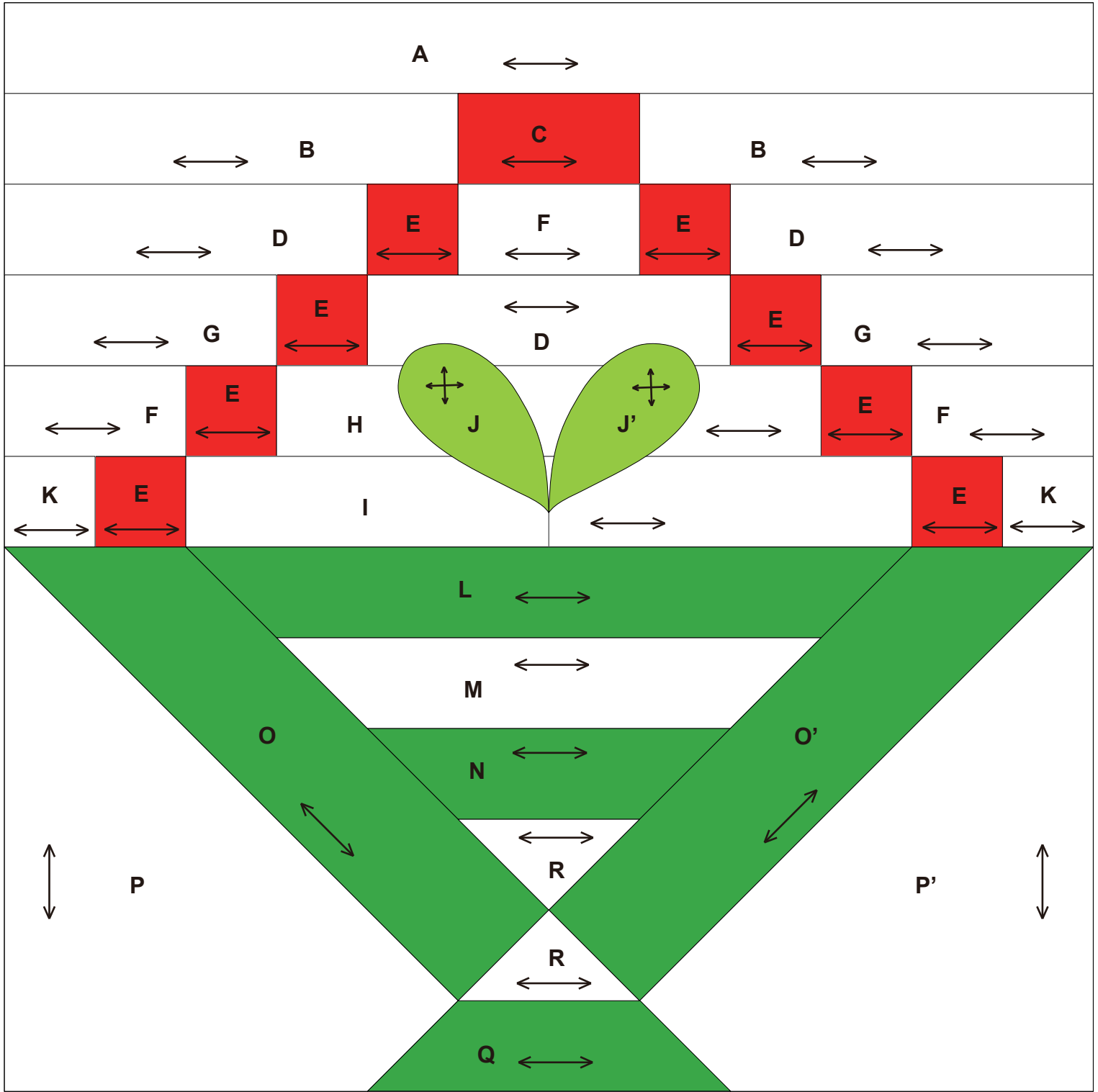

0 1 2 3 4 inches(")

0 50 100 mm

Illustration of finished item

←...Fabric grain
200 mm × 200 mm (8"×8")

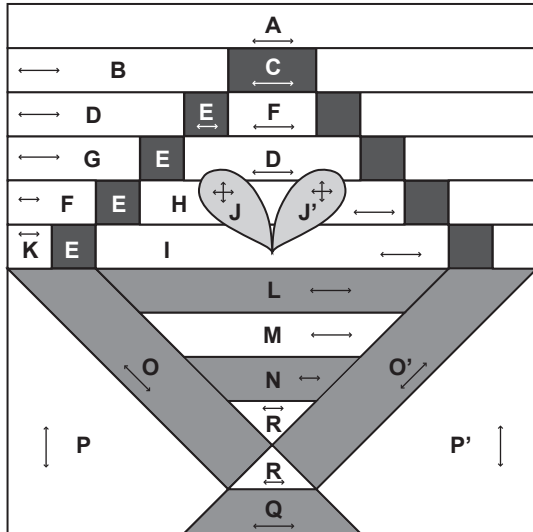

How to make

• Make the sprout blocks

1 Sew together B and C.



2 Sew together D, E and F.



3 Sew together D, E and G.



4 Sew together E, F and H.

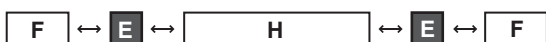

5 Sew together E, I and K.



6 Sew on A, as shown in the figure.

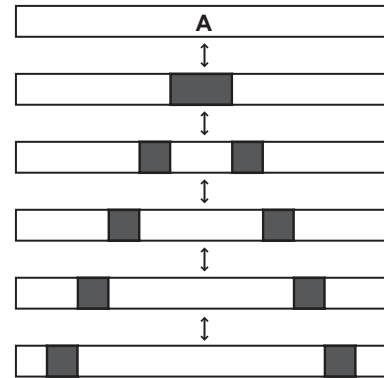

• Make the basket blocks

1 Sew together L, M, N and R.

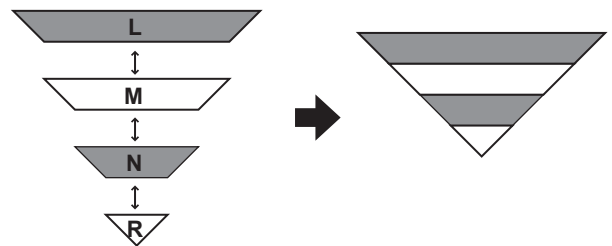

2 Sew together O and P.

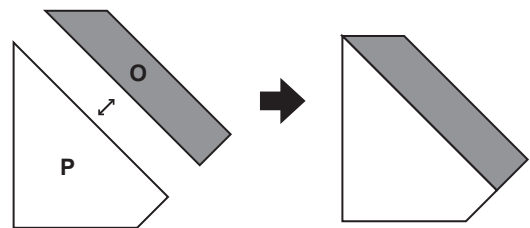

3 Sew together the two blocks, as shown in the figure.

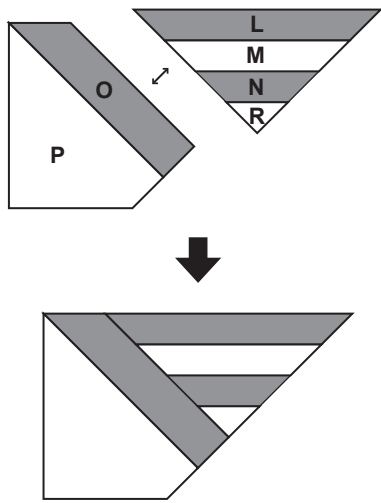

4 Sew together O' and P'.

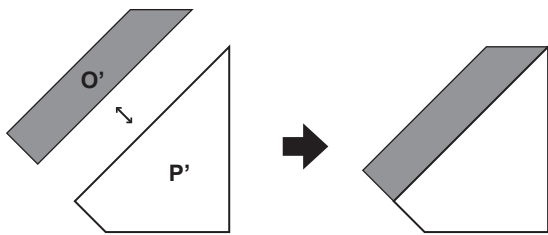

5 Sew together R and Q.

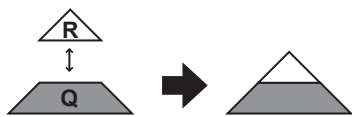

6 Sew together the two blocks, as shown in the figure.

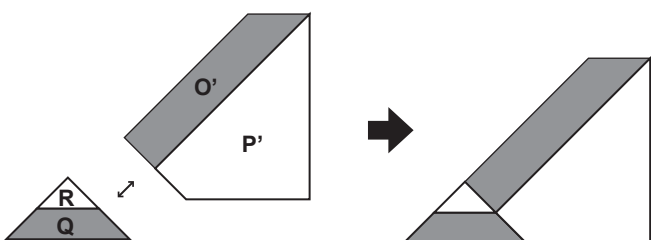

7 Sew together the left and right blocks.

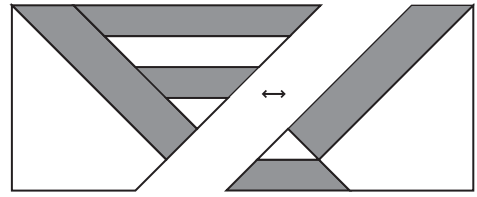

• Sew together the upper and lower blocks

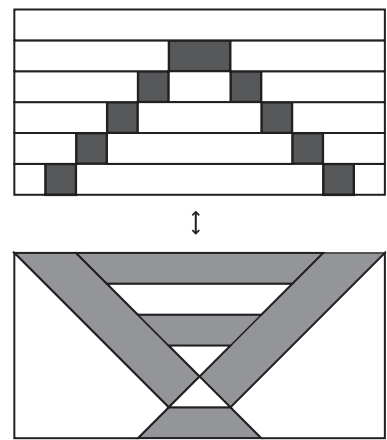

• Appliqué the sprout

1 Place the sewing patterns on the wrong side of the fabric for J and J', and iron them into shape.

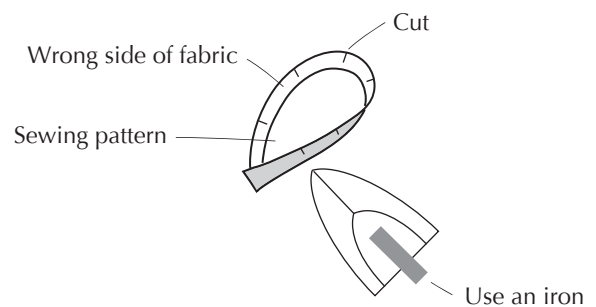

2 Appliqué.

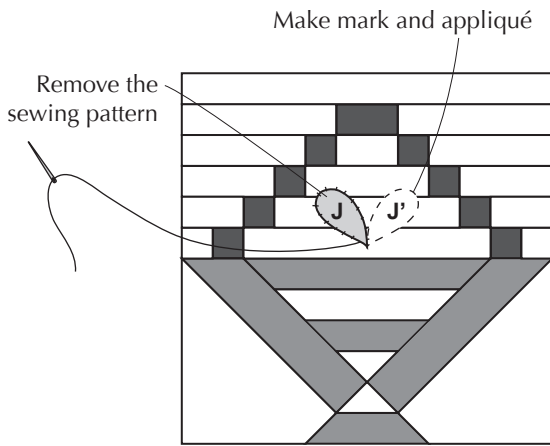

The task is completed.

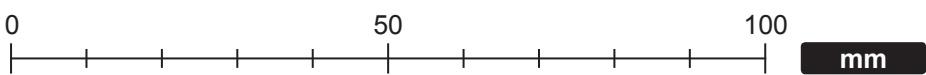
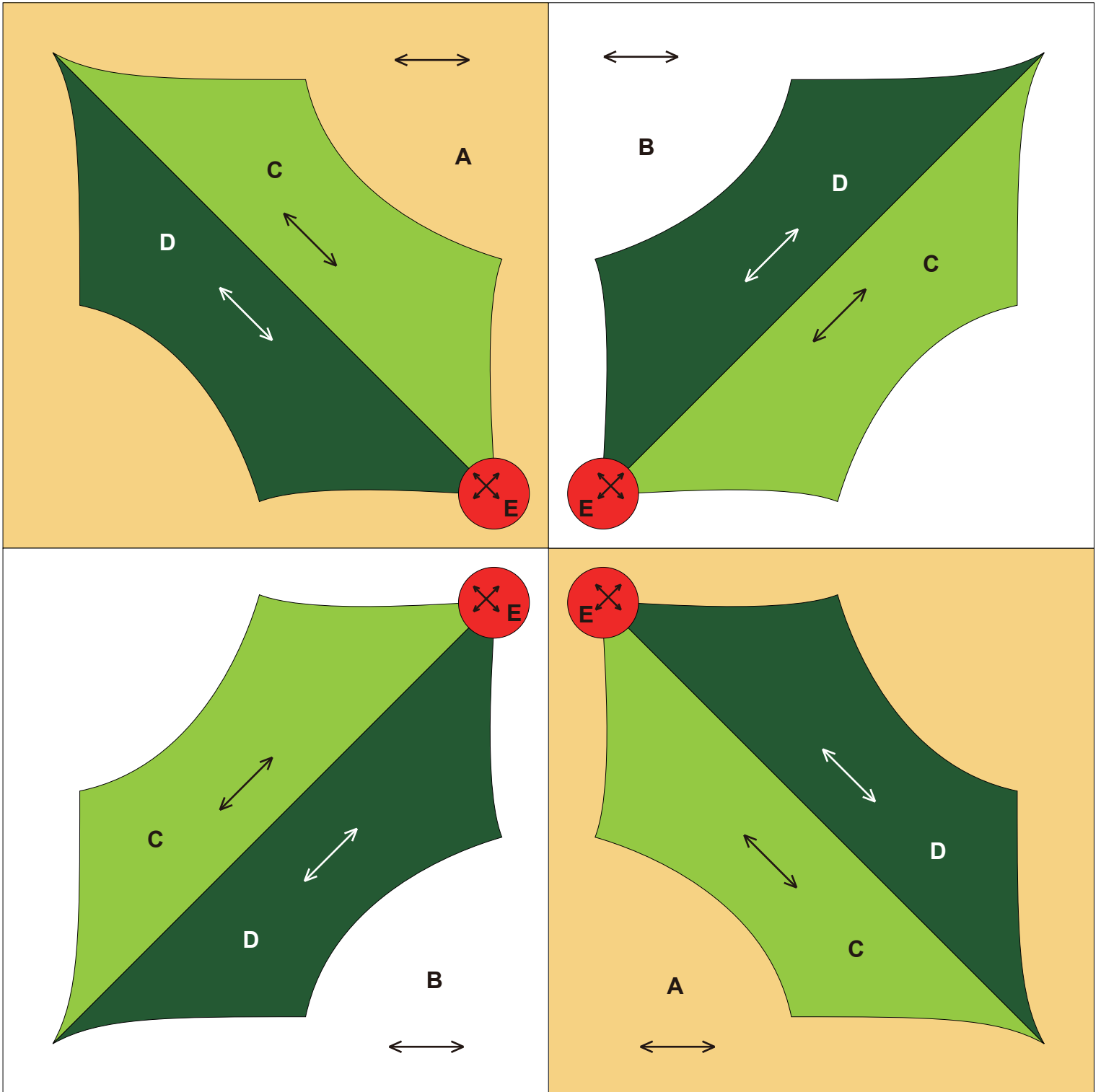
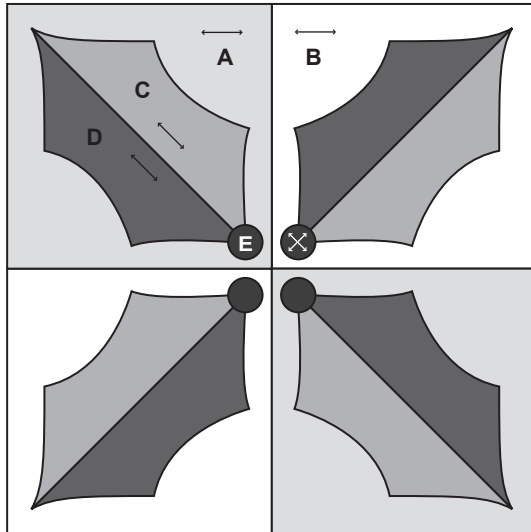

Illustration of finished item

←...Fabric grain
200 mm × 200 mm (8"×8")



How to make

• Make the base material

- 1 Sew together **A** and **B**. (Two pieces)

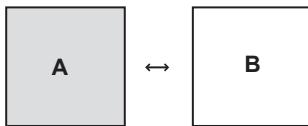

- 2 Sew together the top and bottom.

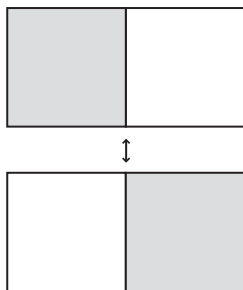

• Appliqué the holly

- 1 Sew together **C** and **D**. (Four pieces)

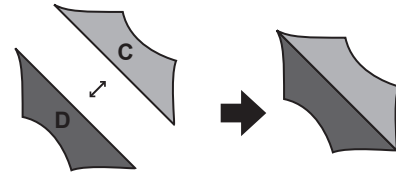

- 2 Place the sewing patterns on the wrong side of the fabric, and iron them into shape.

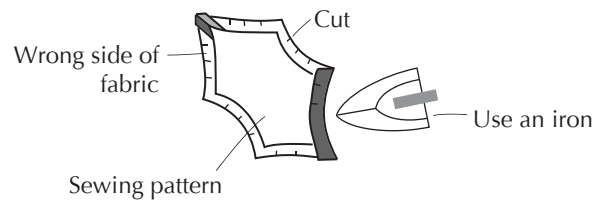

- 3 Make a mark on base material, and appliqué. (Four pieces)

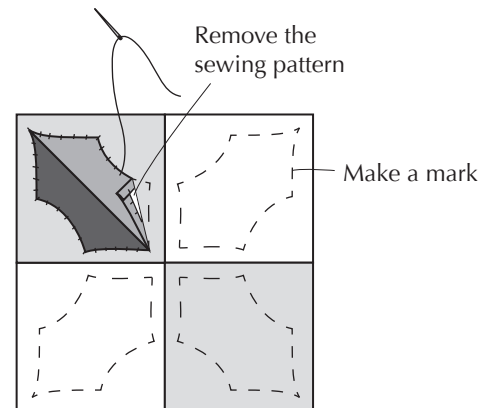

- 4 Appliqué the berry. (Four pieces)
Place the sewing pattern on the wrong side of the fabric, pull tight the running stitch on the seam allowance, and iron into shape.

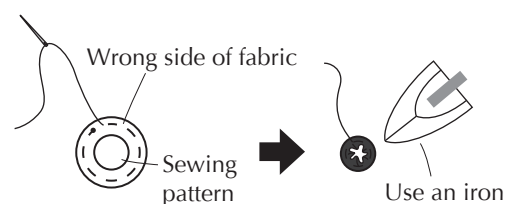

5 Make a mark and appliqué.

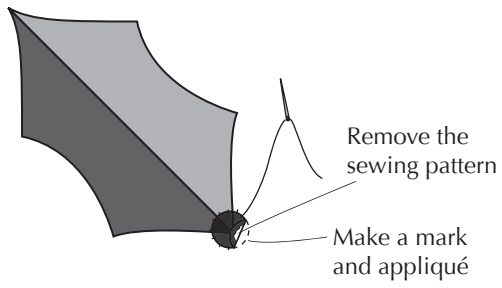

The task is completed.

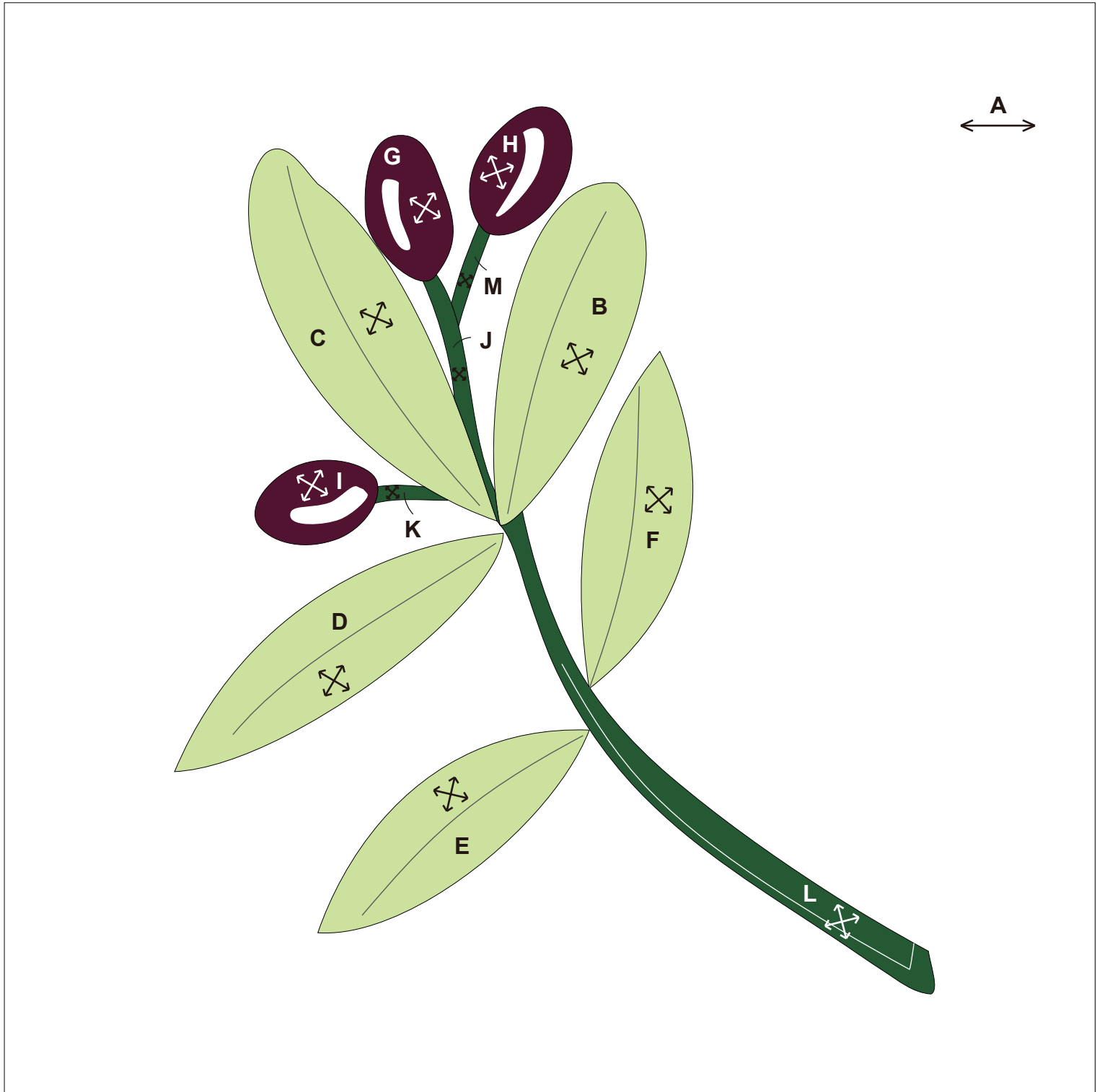

0 1 2 3 4 inches(")

0 50 100 mm

Illustration of finished item

←...Fabric grain
200 mm × 200 mm (8"×8")

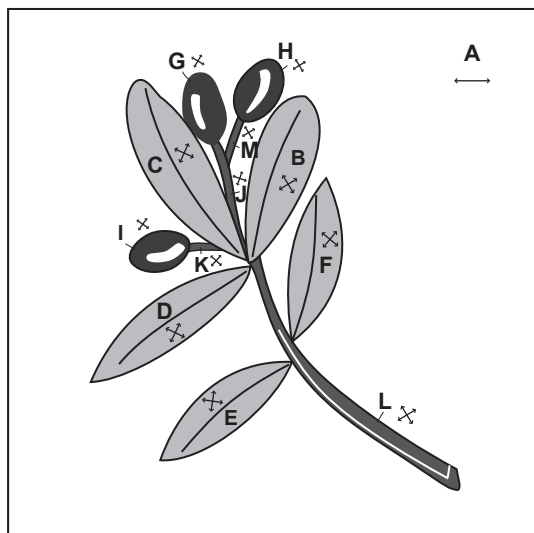

How to make

- Make a mark on base material A, and appliqué the stem

- 1 While folding under the seam allowance, first appliqué M and K, and then J and L.

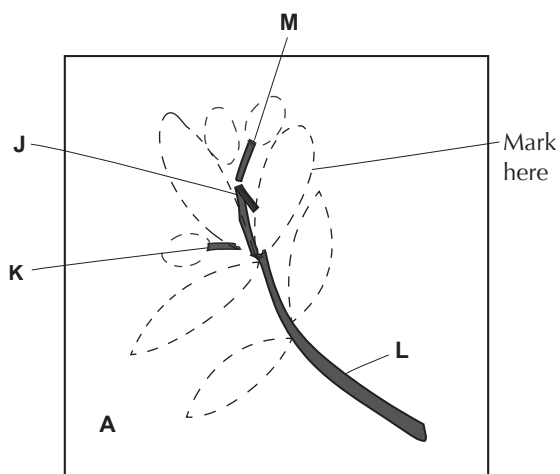

• Appliqué the leaves and berries

- 1 On the leaves, place the sewing patterns on the wrong side of the fabric, and iron them into shape. On the berries, make a running stitch in the seam allowance and pull tight.

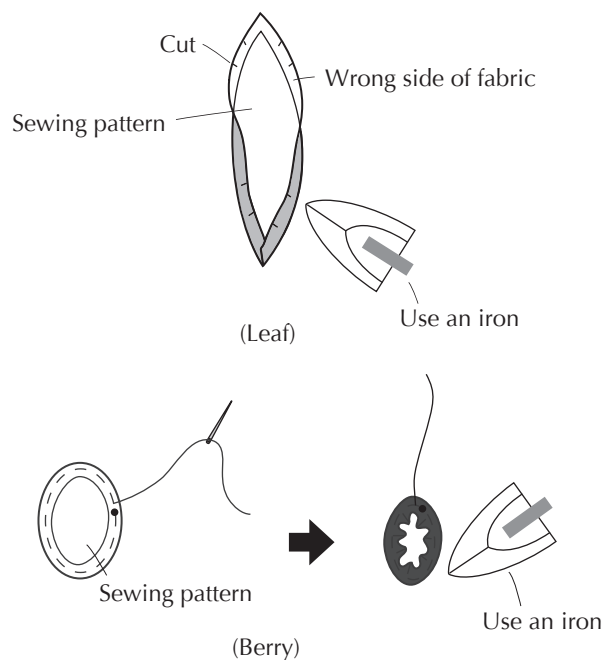

- Embroider on the leaf veins and the gloss on the stem and berries

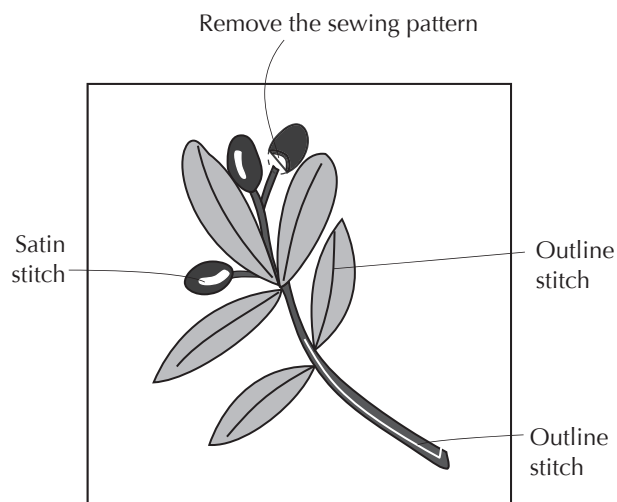

The task is completed.

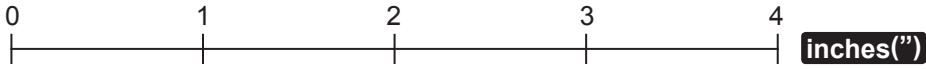
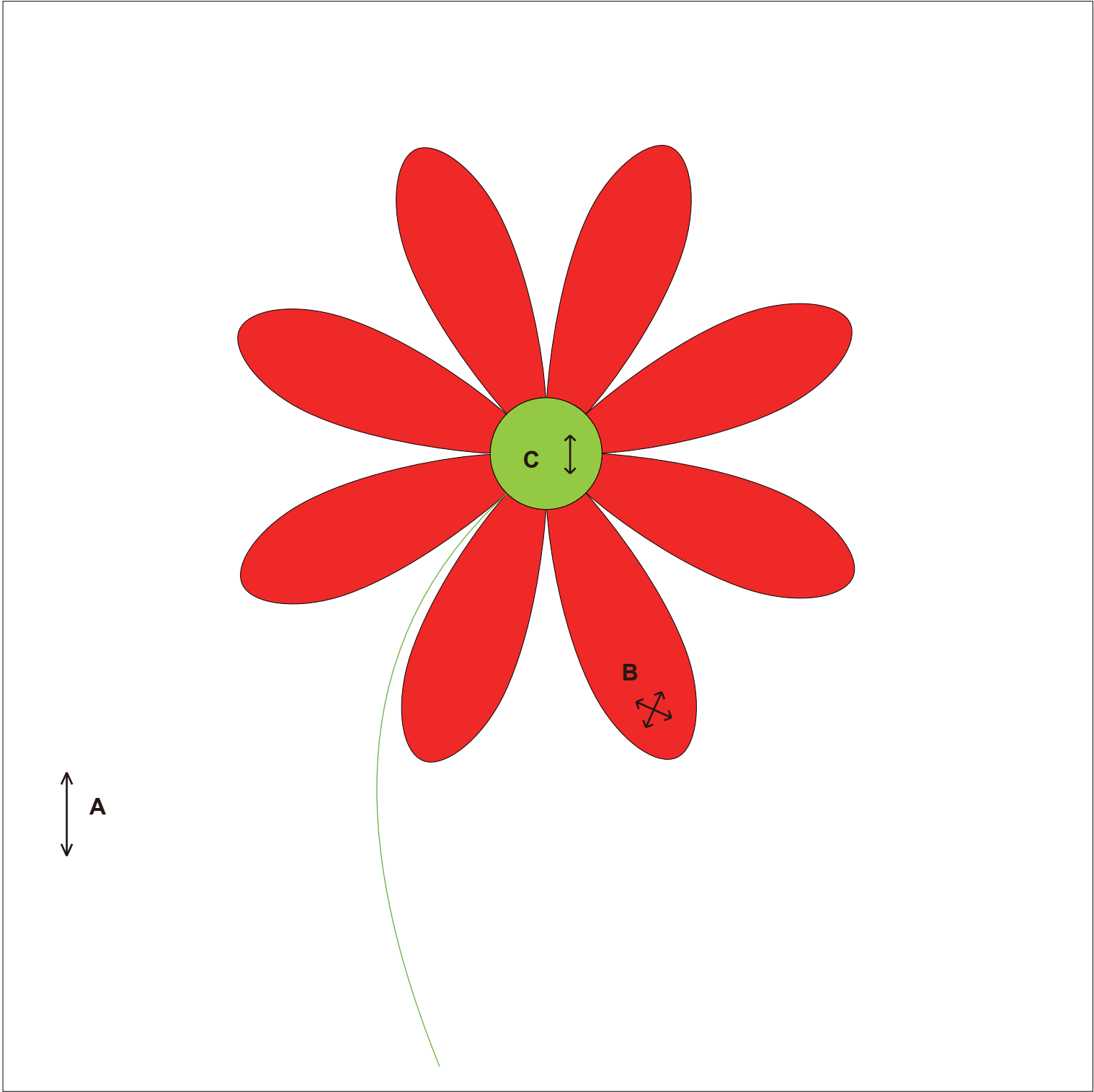
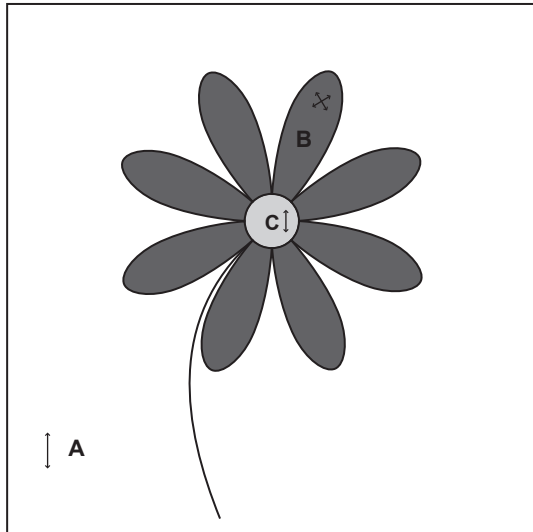

Illustration of finished item

←...Fabric grain
200 mm × 200 mm (8"×8")



How to make

- Make eight margaret flower petal pieces and one piece for the center of the flower

- 1 For the flower petals, place the sewing patterns on the wrong side of the fabric, and iron them into shape. For the center of the flower, make a running stitch in the seam allowance and pull tight.

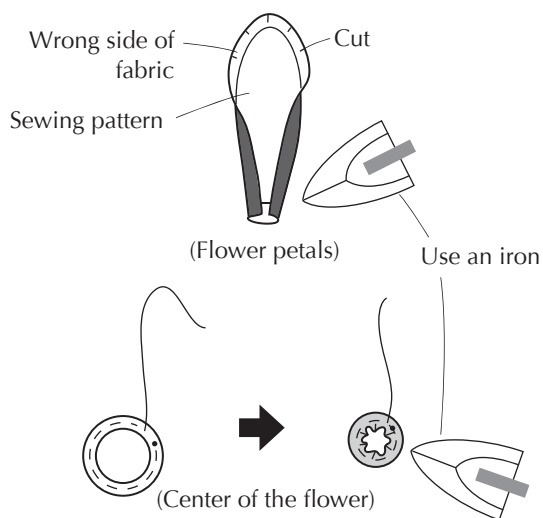

- Make a mark on base material A, and appliqué the flower petals

Do not appliqué on the area where the fabric is doubled up (Do not fold in the seam allowance)

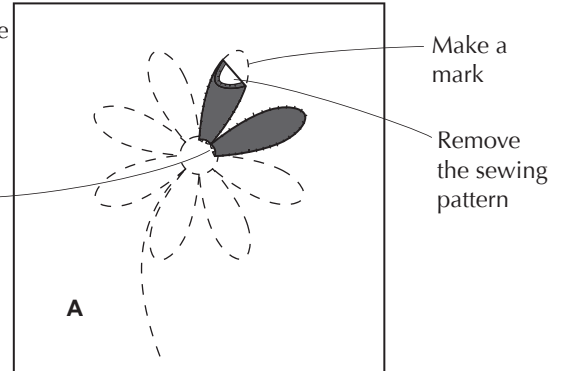

- Appliqué the center onto the middle of the flower, and embroider on the stem

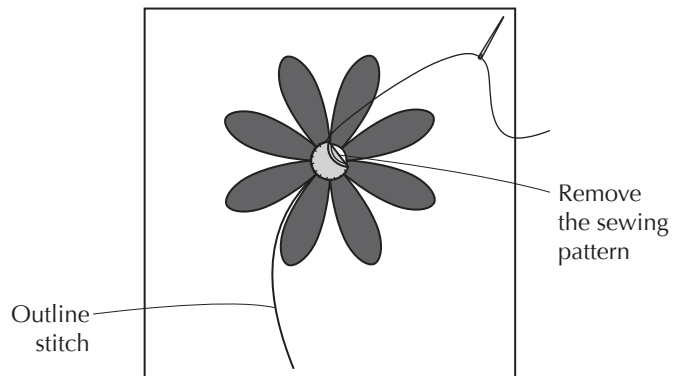

The task is completed.

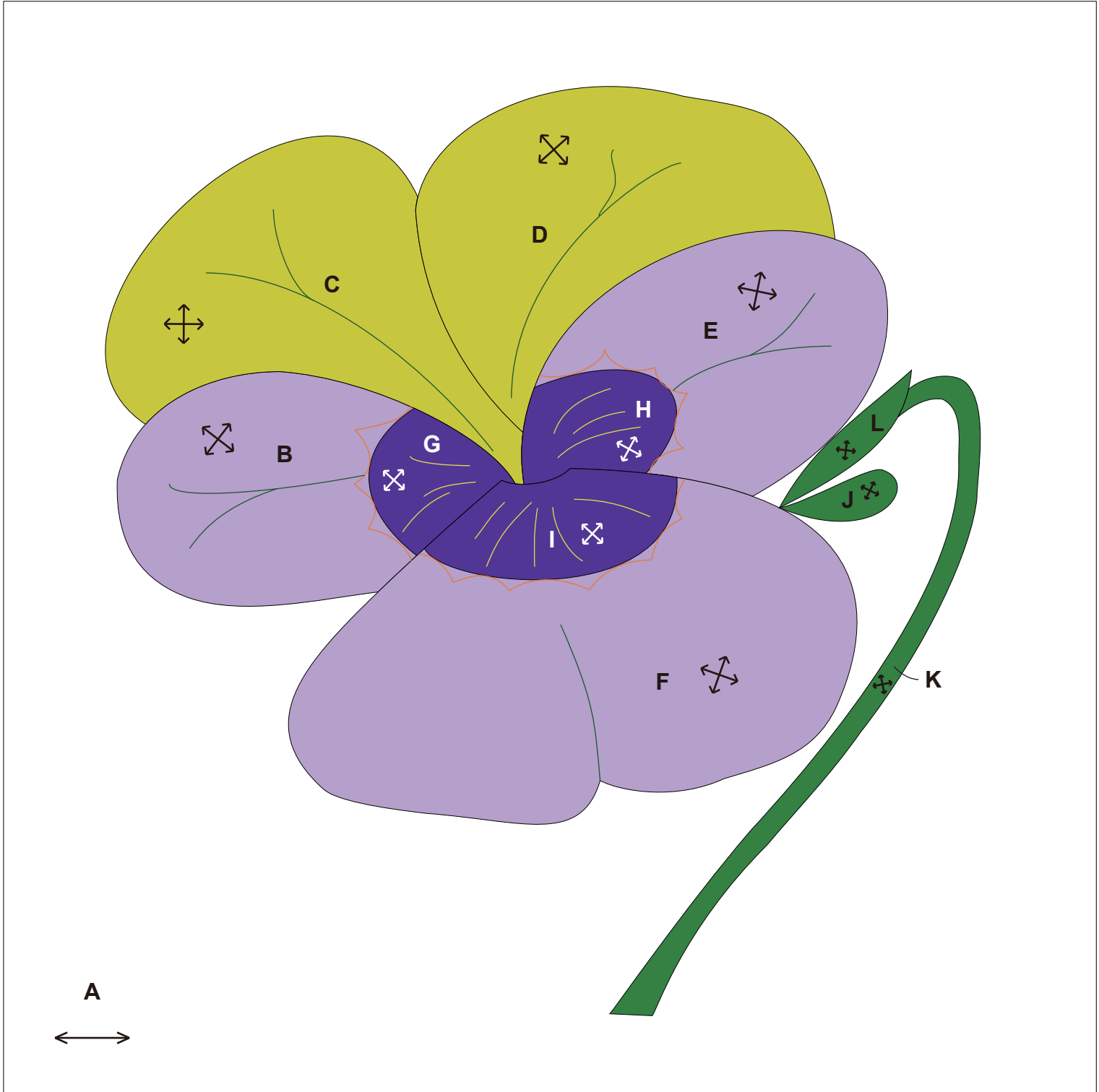

0 1 2 3 4 inches(")

0 50 100 mm

Illustration of finished item

←...Fabric grain
200 mm × 200 mm (8"×8")

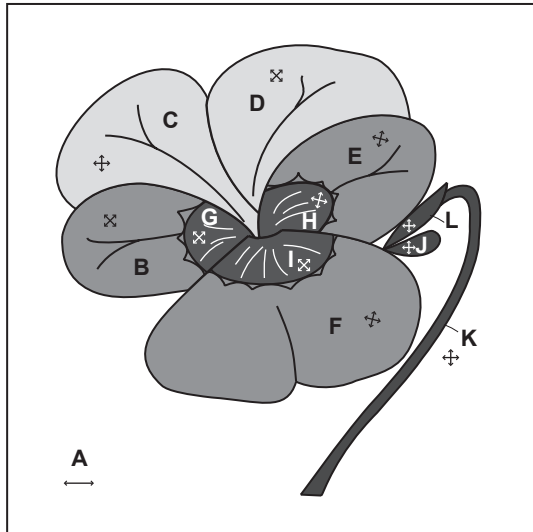

How to make

• Appliqué

Make a mark on base material **A**, and appliqué, folding under the seam allowance in order from the pieces that will be on the bottom.

<Appliqué order>

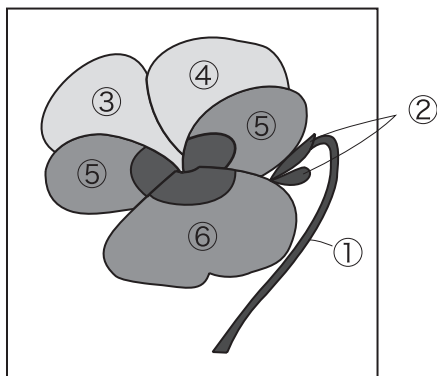

- 1 Place **G** on top of **B** and appliqué, making it into a single piece.
In the same way, appliqué **E** and **H**, **F** and **I**.

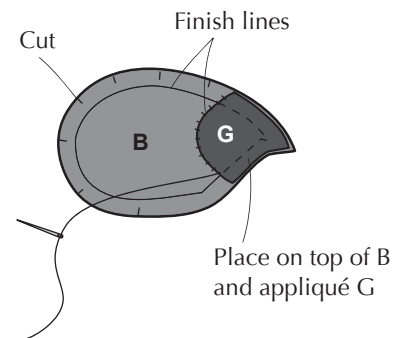

- 2 Appliqué in order from the pieces that will be on bottom.
Places where the fabric is doubled up will not be seen, so leave them as is and appliqué.

Do not appliqué on the area where the fabric is doubled up (Do not fold in the seam allowance)

Make a mark

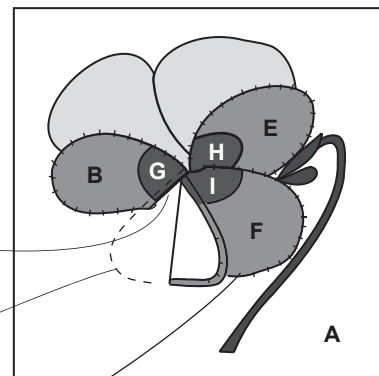

• Embroider the flower's appearance

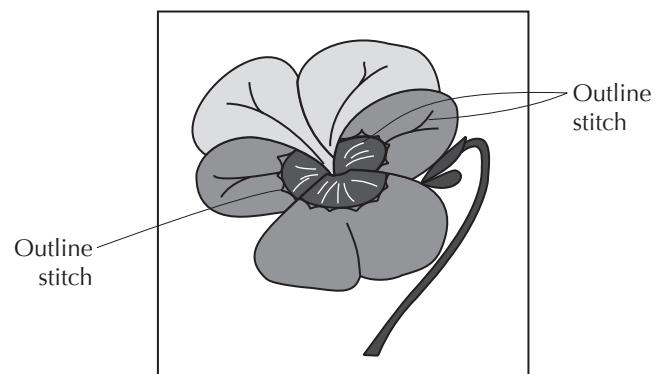

The task is completed.

41

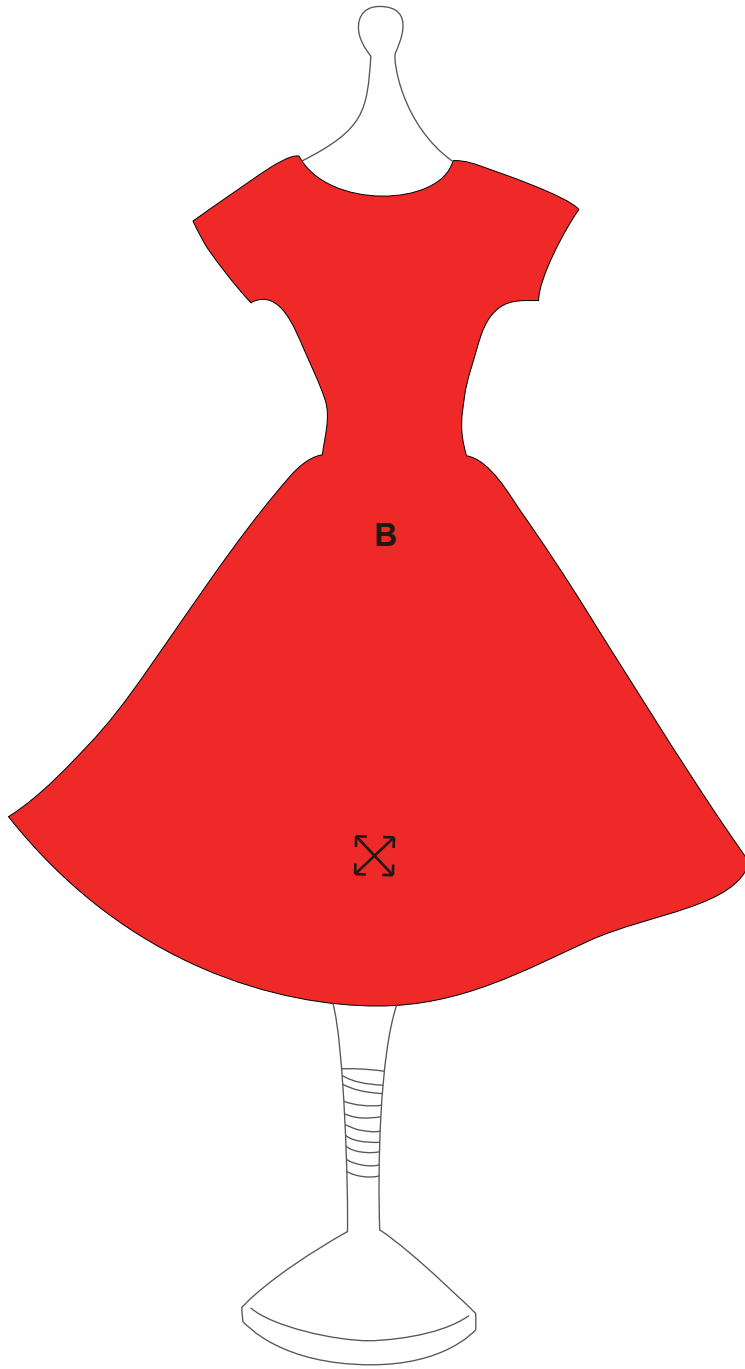

0 1 2 3 4 inches(")

0 50 100 mm

41

Parisian fashion

Illustration of finished item

←...Fabric grain
200 mm × 200 mm (8"×8")

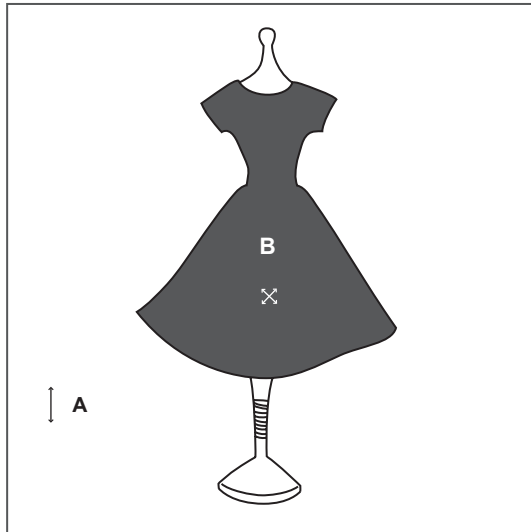

How to make

• Appliqué the dress

- 1 Make cuts in the seam allowances in corners and curving areas.

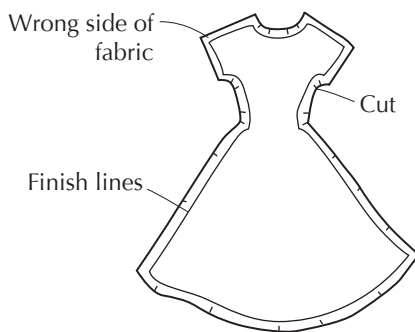

- 2 Make a mark on base material A, and appliqué, folding under the seam allowance.

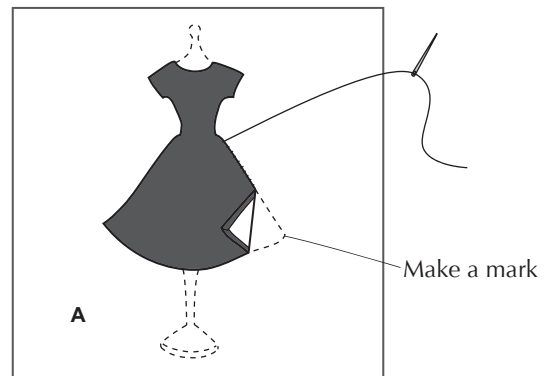

• Embroider in the torso base

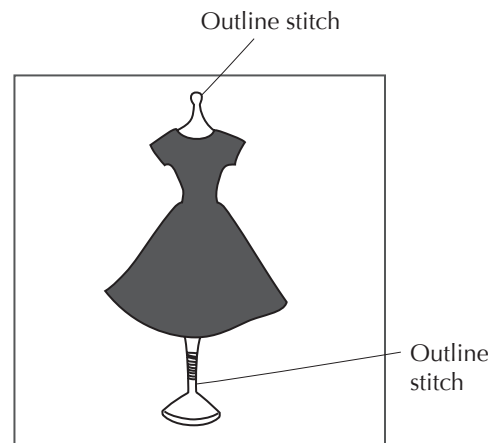

The task is completed.

A ↔

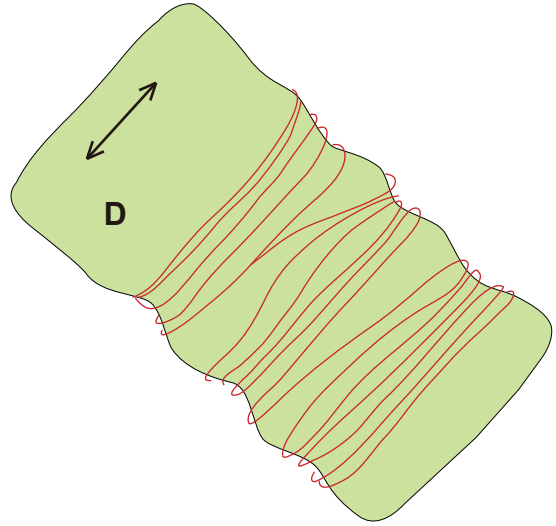
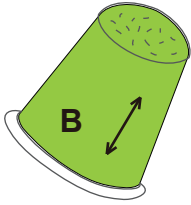

POOL

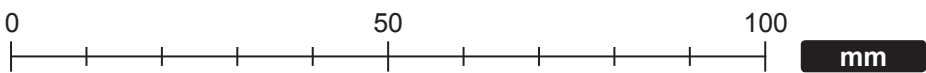
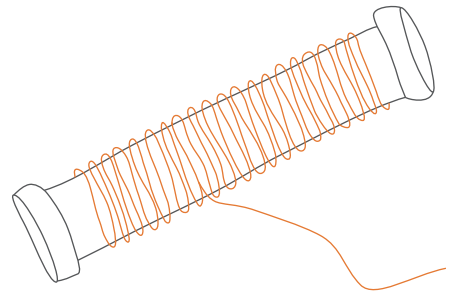
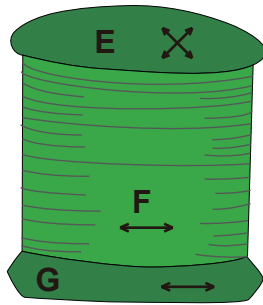
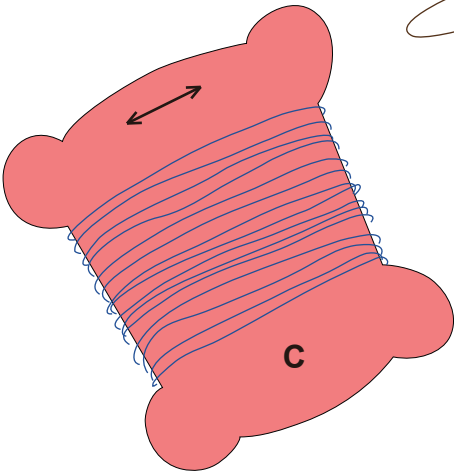
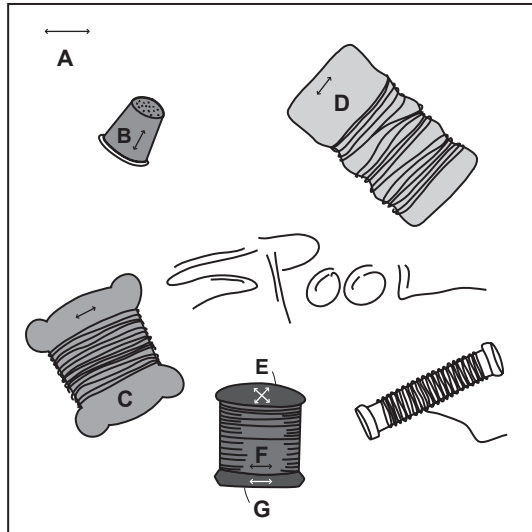

Illustration of finished item

←...Fabric grain
200 mm × 200 mm (8"×8")



How to make

• Appliqué

Make a mark on base material **A**, and appliqué the spool of thread and the thimble, folding under the seam allowance.

1 For the spool of thread, sew together **E**, **F** and **G**.

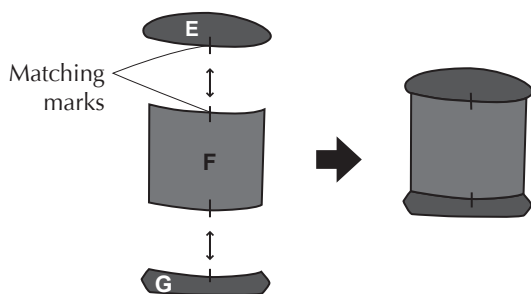

2 Make cuts in the seam allowances in corners and curving areas.

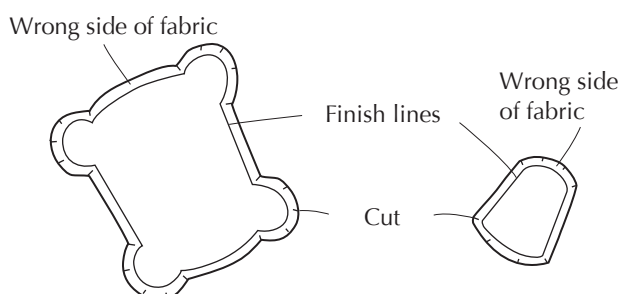

3 Appliqué.

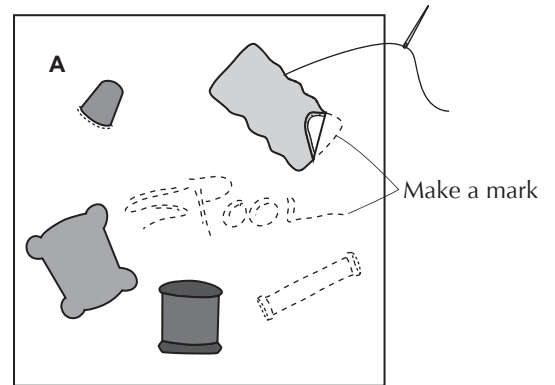

• Embroider the spool of thread, thread, thimble and letters

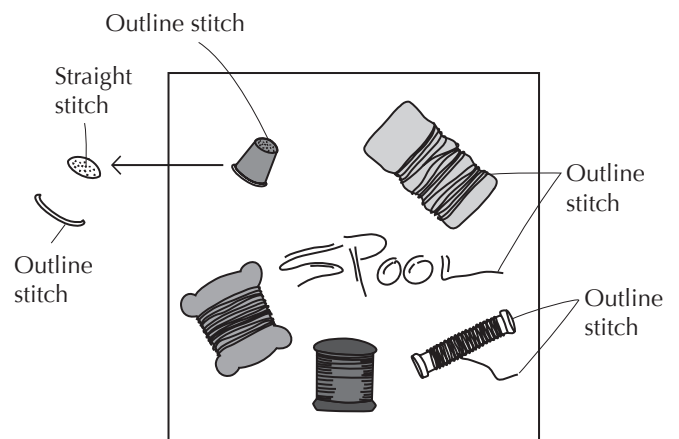

The task is completed.

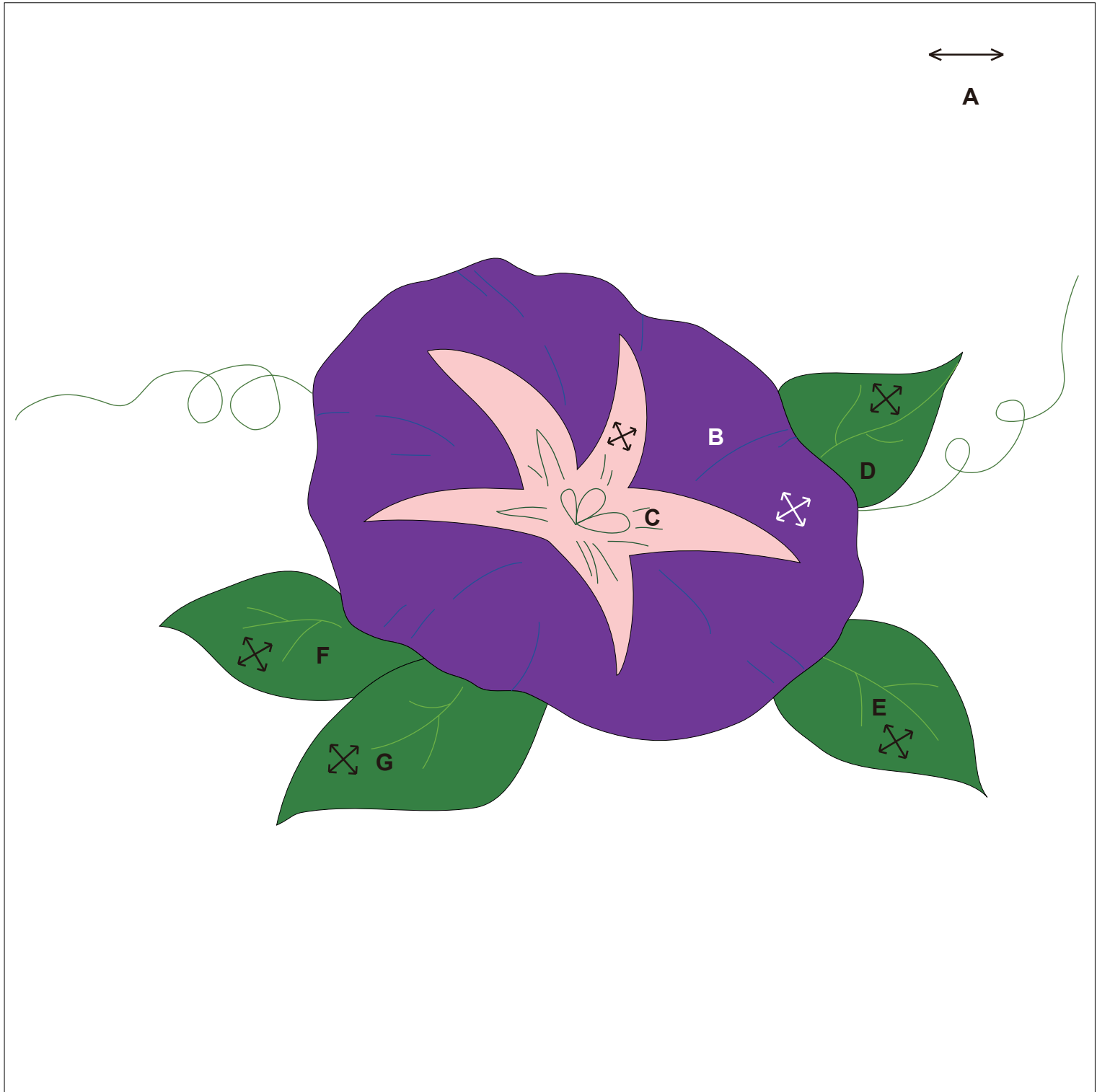

↔
A

B

↔

D

↔

C

↔

↔

F

↔

G

↔

E

0 1 2 3 4 inches(")

0 50 100 mm

Illustration of finished item

←...Fabric grain
200 mm × 200 mm (8"×8")

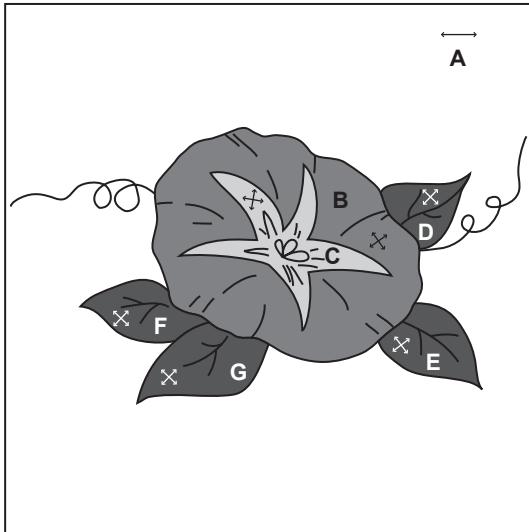

How to make

• Appliqué the leaves

- 1 Make cuts in the seam allowances in the curving areas of the leaves **D**, **E**, **F** and **G**.



- 2 Make a mark on base material **A**, and appliqué, folding under the seam allowance.

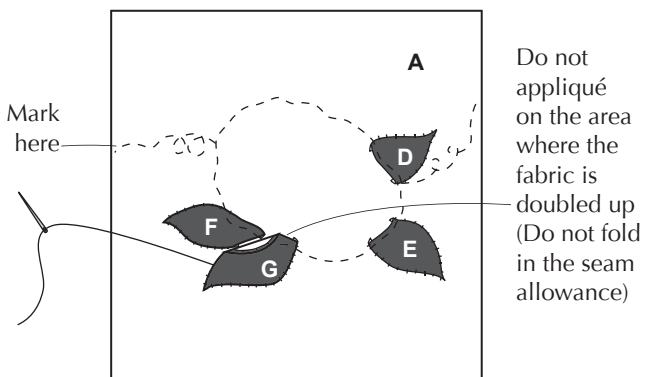

• Appliqué the flower

- 1 Appliqué **B**, and then appliqué **C** on top.

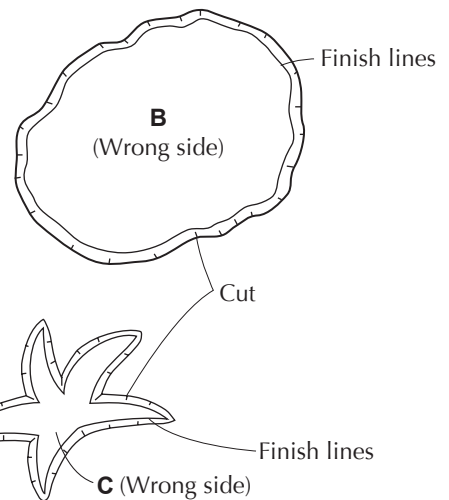
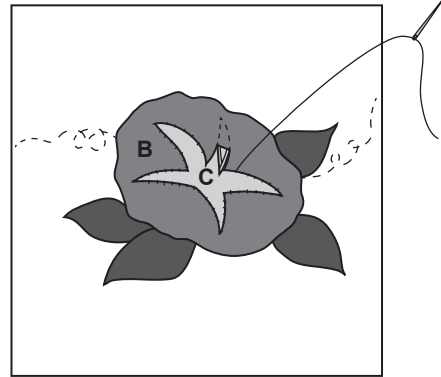

• Embroider the leaf veins, the center of the flower and the vines, etc.

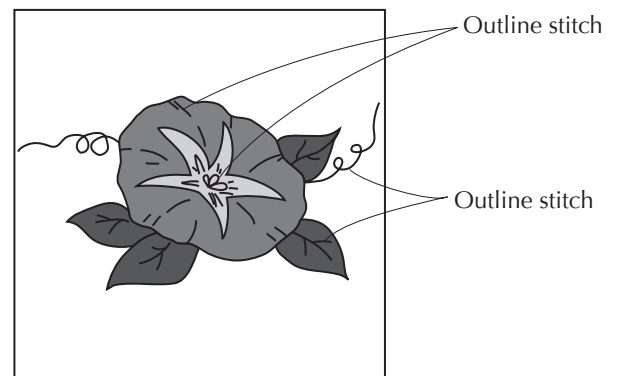

The task is completed.



0 1 2 3 4 inches(")

0 50 100 mm

Illustration of finished item

←...Fabric grain
200 mm × 200 mm (8"×8")

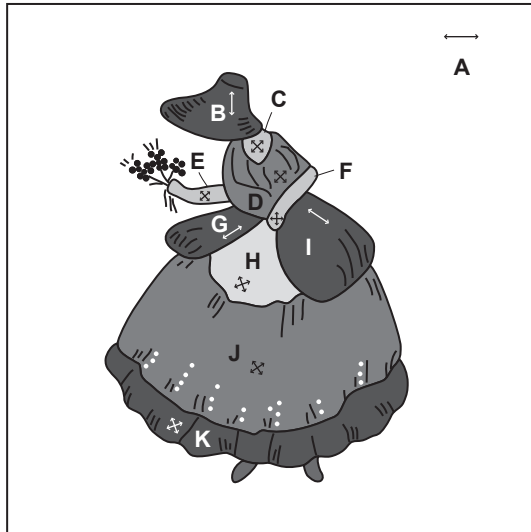

How to make

• Appliqué

Make a mark on base material **A**, and appliqué, folding under the seam allowance in order from the pieces that will be on the bottom.

(Appliqué order)

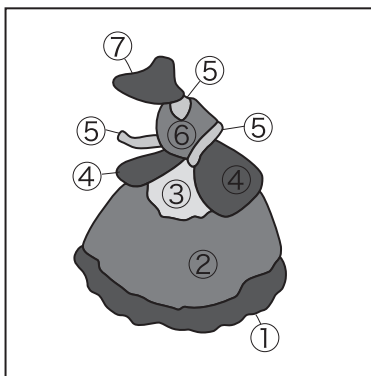

- 1 Make cuts in the seam allowances in curving areas of pieces to be appliquéd.

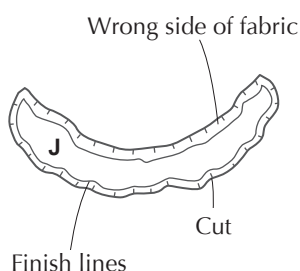

- 2 Appliqué **J** and **K**.
In the same way, appliqué **H**, **G** and **I**.

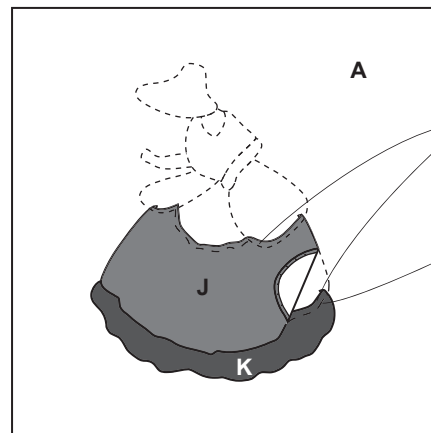

Do not appliqué on the area where the fabric is doubled up (Do not fold in the seam allowance)

Finish lines

- 3 Appliqué **C**, **E** and **F**, and then appliqué **D** and **B** on top.

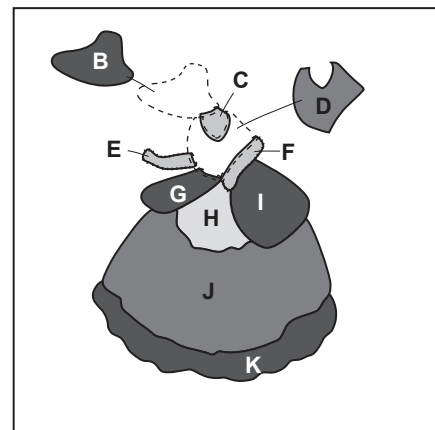

- Embroider the flowers, shoes and wrinkles and patterns on the clothes, etc.

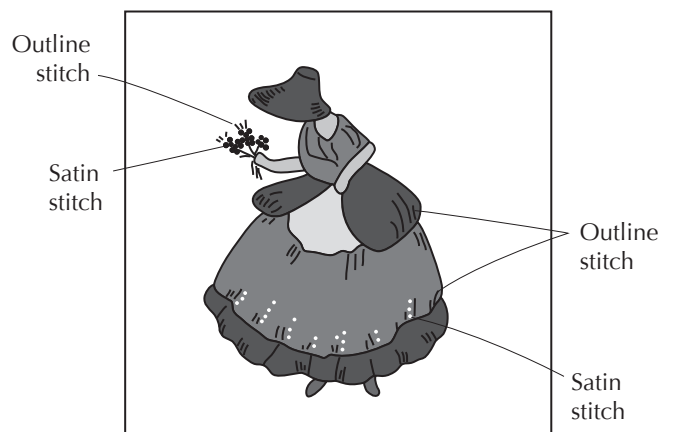

The task is completed.

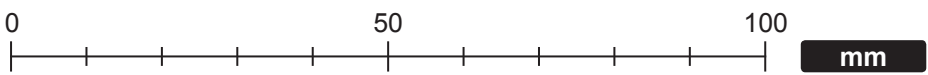
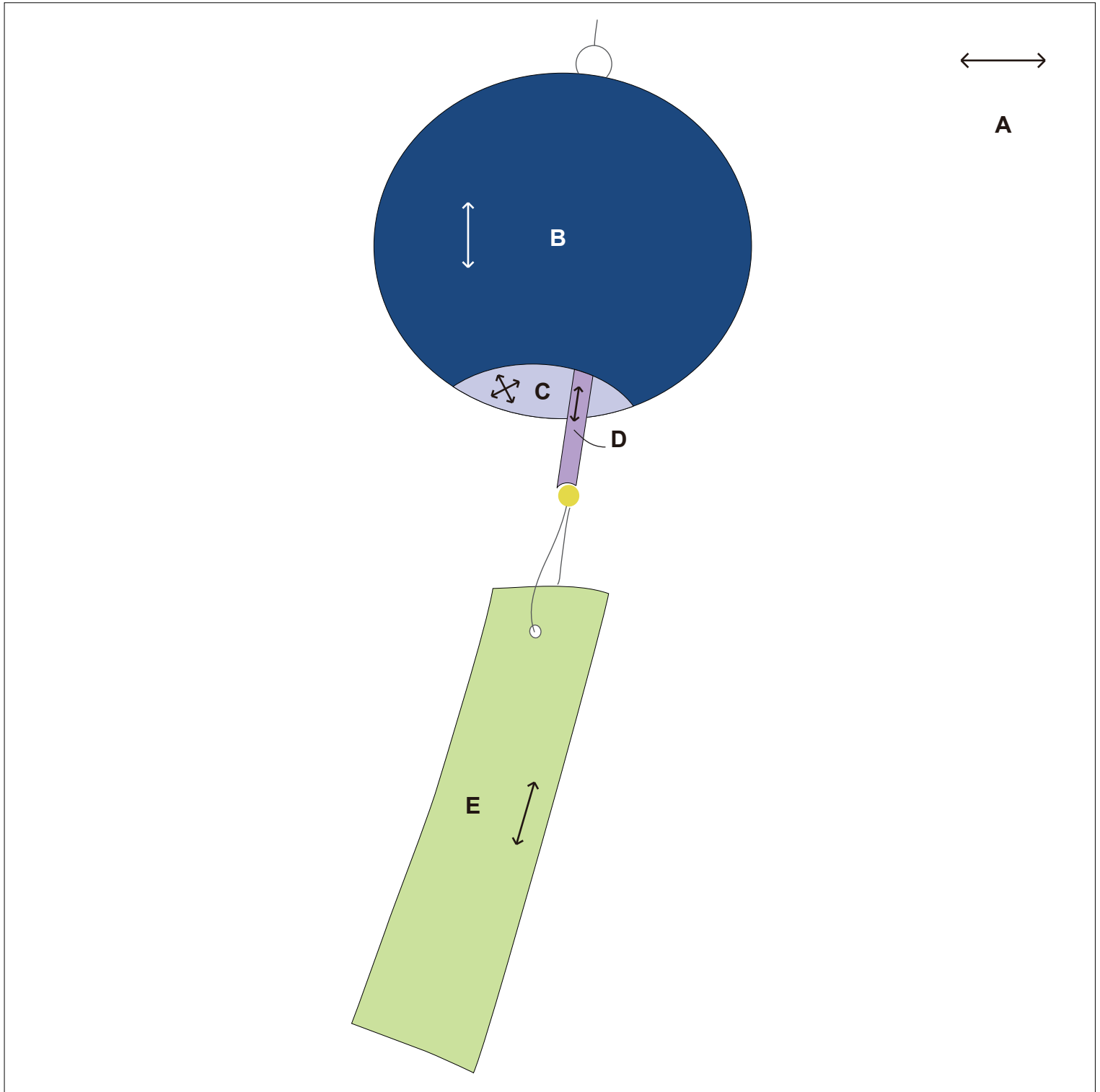
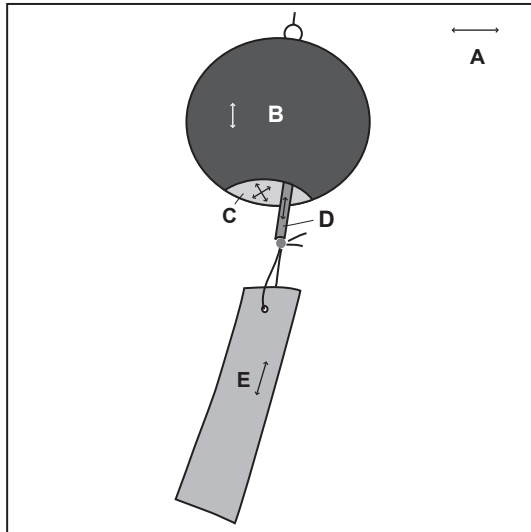

Illustration of finished item

←...Fabric grain
200 mm × 200 mm (8"×8")



How to make

• Appliqué the wind chime

- 1 Place the sewing pattern on the **B** and **C**, pull tight the running stitch on the curving lines as shown in the figure, and iron into shape.

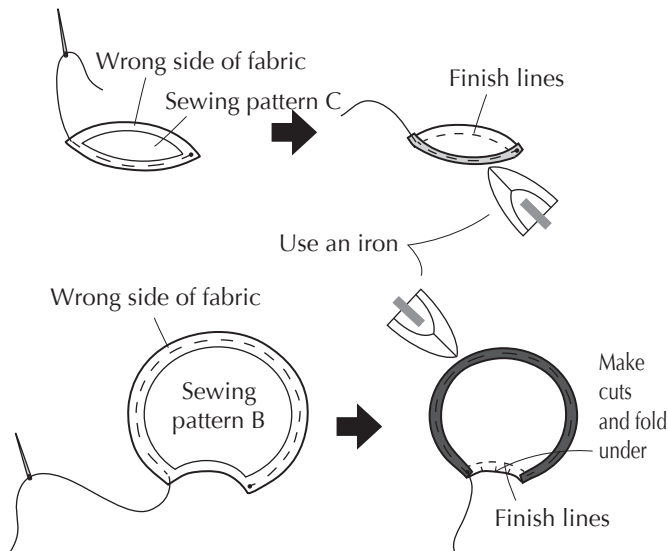

- 2 Make a mark on base material **A**, and appliqué **C**, **D** and **B** in that order on top of one another.

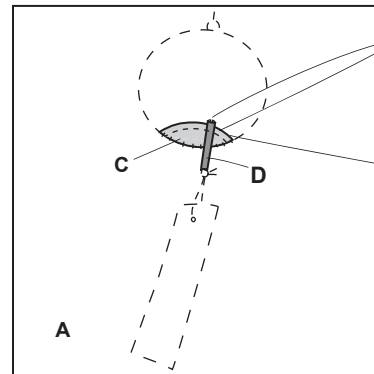

Do not appliqué on the area where the fabric is doubled up (Do not fold in the seam allowance)
Remove the sewing pattern

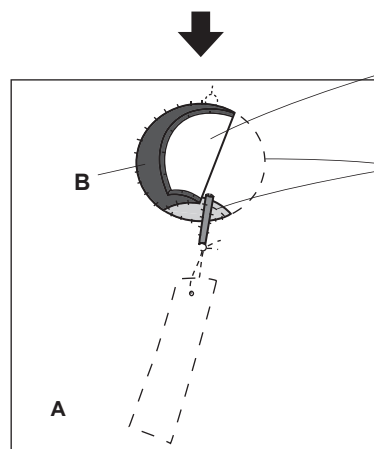

Remove the sewing pattern
Finish lines

• Appliqué the paper strip

- 1 Appliqué, folding under the seam allowance.

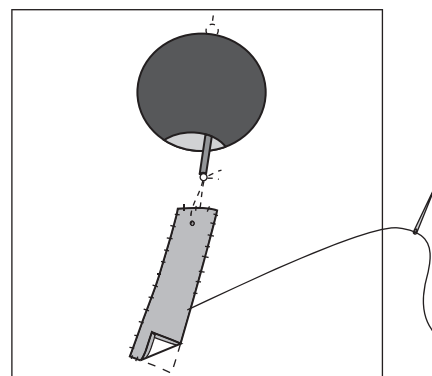

- Embroider the string, clapper etc.
-

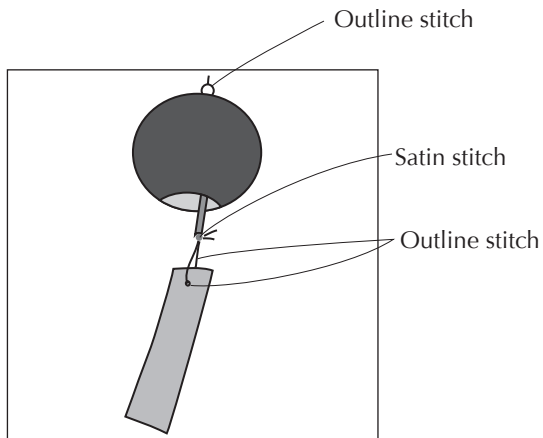

The task is completed.

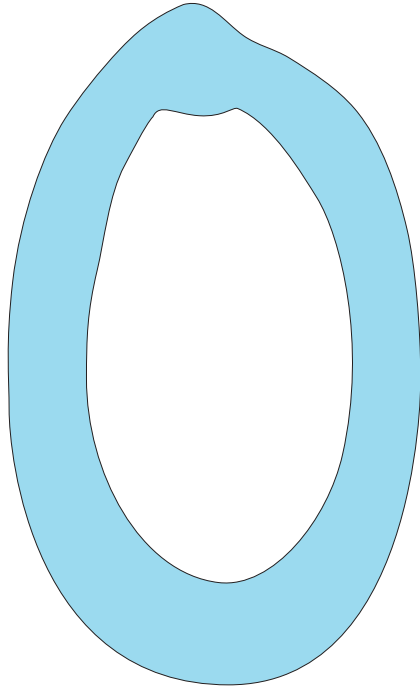

47

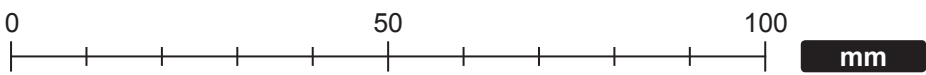
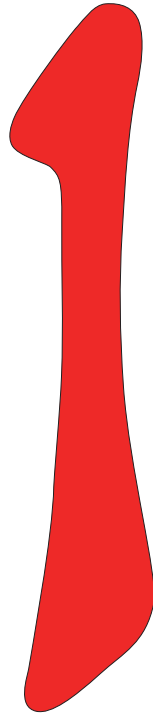

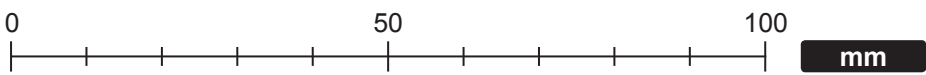
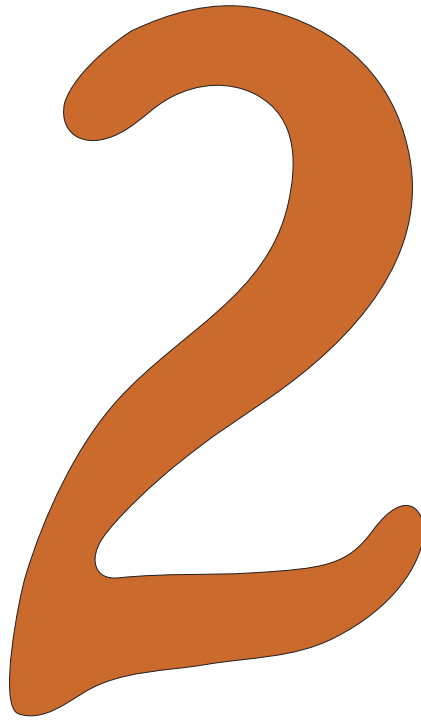

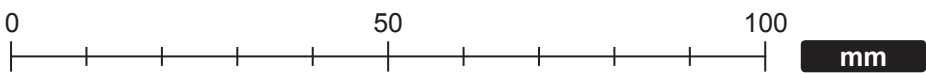
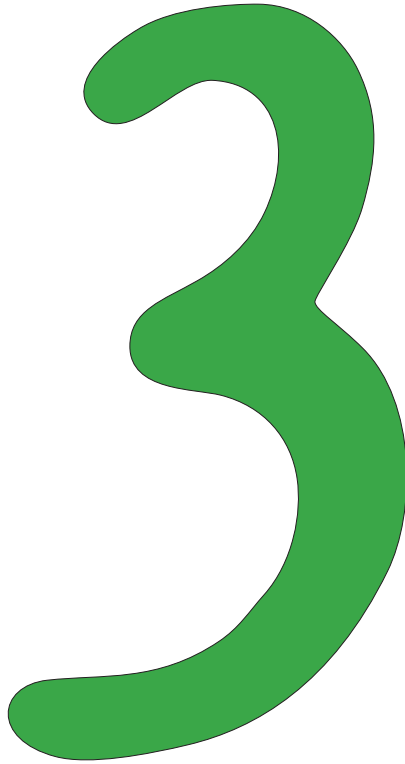

50

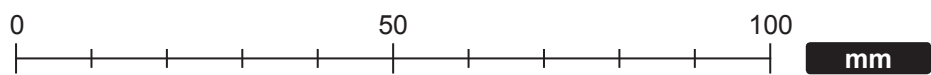
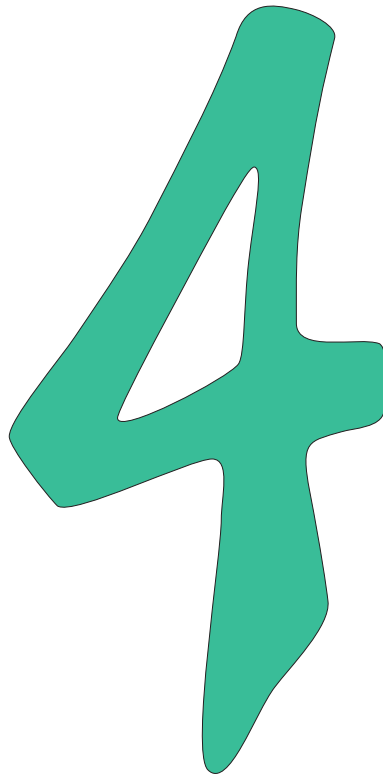

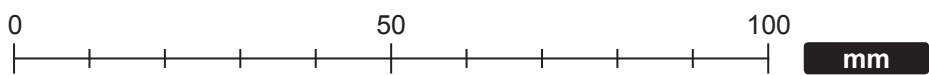
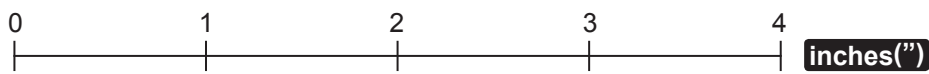
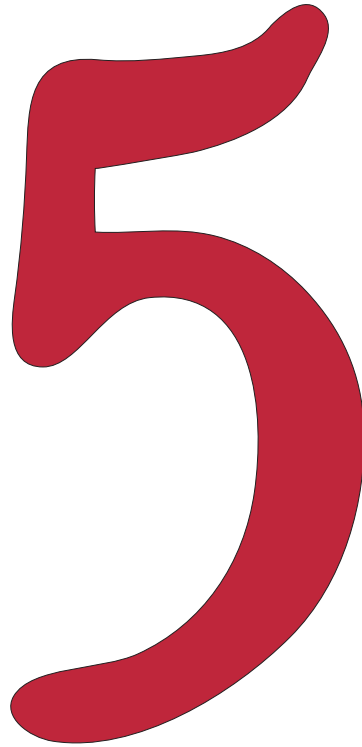

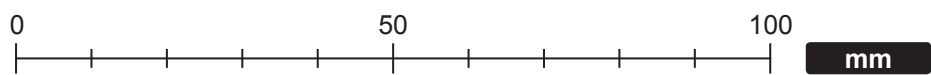

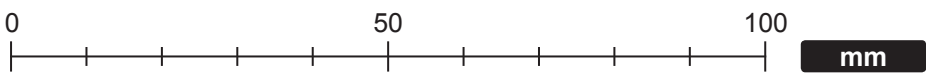
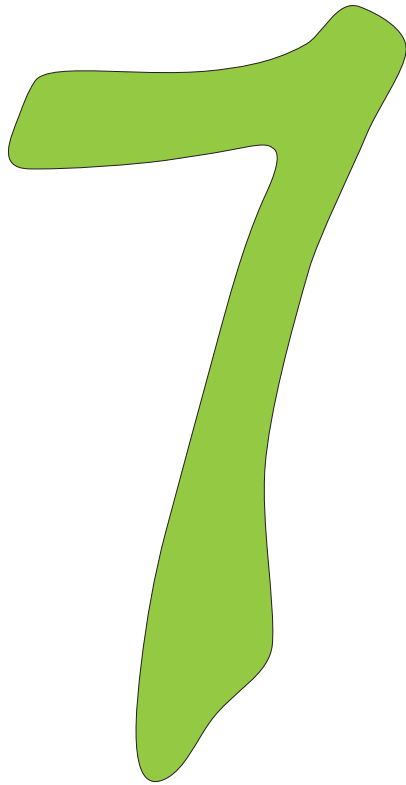

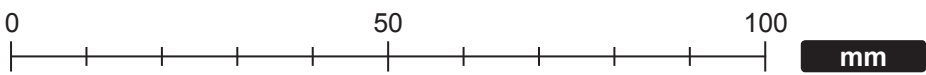
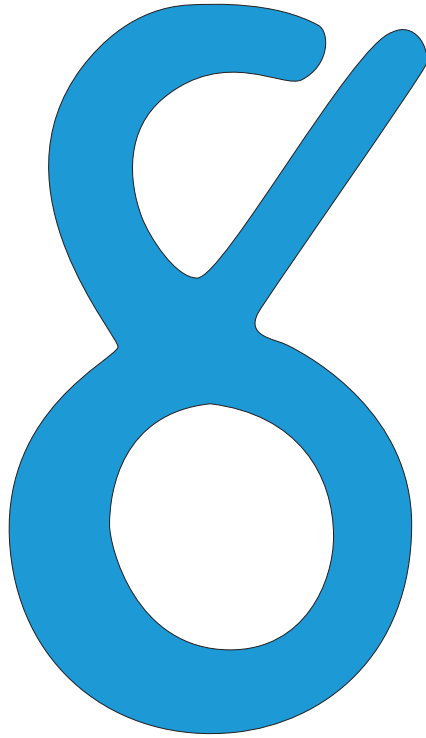

55

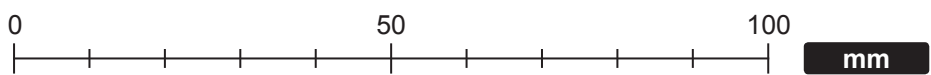
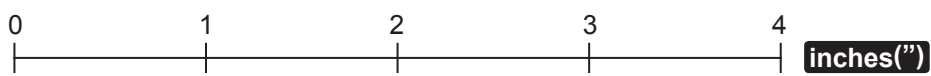
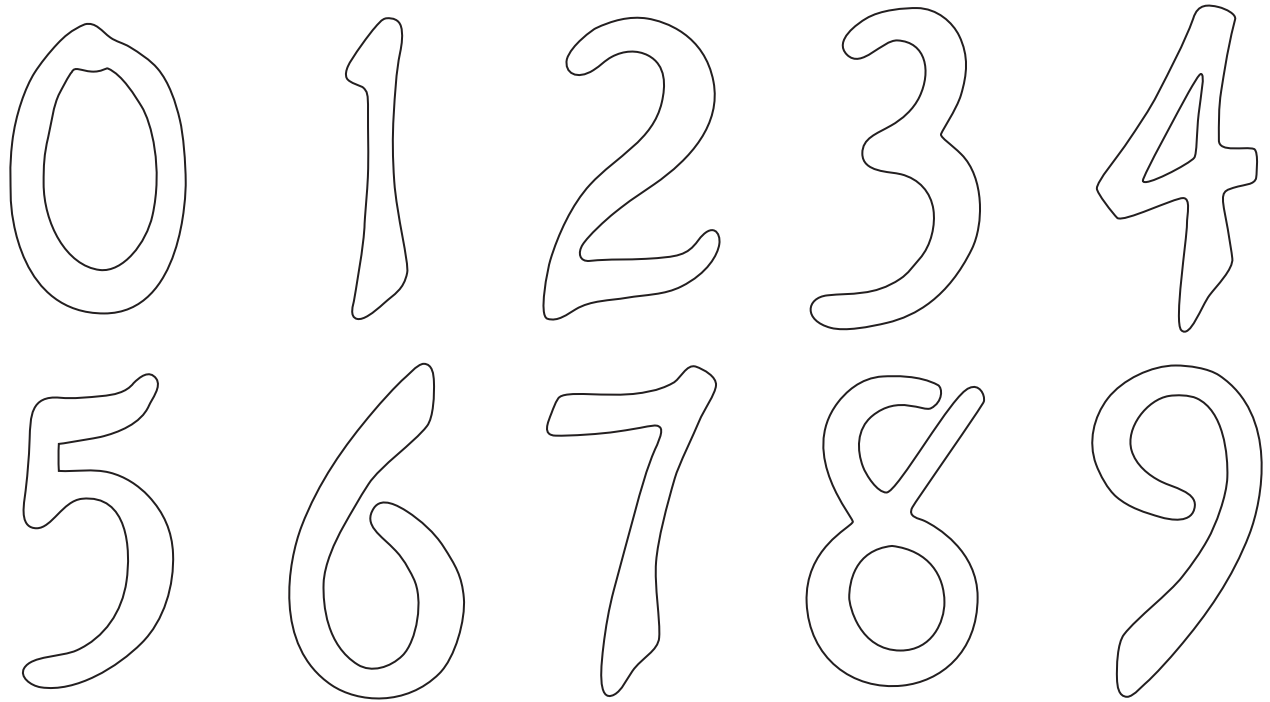

Illustration of finished item



How to make

• Appliqué without seam allowance (no seam allowance)

Attach these appliqués using the handstitch/sewing stitch of your choice.

Memo: Today's sewing machines offer wide variety of stitches. Using the recommend attachment feet will aid in proper stitch formation while sewing.

<Straight stitch>

Use small stitches so that the thread does not stand out. Alternatively, you might also use a thick colored thread and make casual stitches.

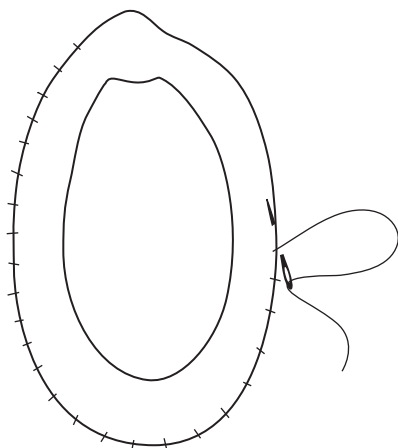

<Buttonhole stitch>

You can embroider around the outside of the figures using a buttonhole stitch to sew them on tightly.

